

Zeta SKY

30÷240 kW



General

Chillers and reversible heat pumps with hermetic scroll compressors and plate heat exchanger. Extended range, versatile applications.

Configurations

Standard: Chiller version

HP: reversible heat pump version

Hi: chiller with inverter compressor

Hi HP: Reversible heat pump version, with inverter compressor

/LN: low-noise unit

/SLN: super low noise version

/HWT: High water temperature on user side

/DS: execution featuring a desuperheater

/DC: execution with recovery condenser

Strengths

- ▶ Conforming with Ecodesign Reg. 2281, tier 2
- ▶ High efficiency and compact dimensions
- ▶ High output water temperature: up to 60°C
- ▶ Reduced refrigerant charge
- ▶ BlueThink advanced control with integrated web server. Multilogic function and Blueye® supervision system. (options)
- ▶ Flowzer: inverter driven pumps (options)

BlueBox 
by Swegon

Zeta SKY

Description of accessories	10
Refrigerant circuit accessories	10
Fan accessories	12
Hydraulic circuit accessories	13
Flowzer options	15
Electrical accessories	29
Network accessories	35
Other accessories	38
Technical specifications	41
Ecodesign	63
Electrical specifications	75
Hydraulic modules	89
Pump data	92
User-side exchanger flow rate fields	93
Operating limits	95
Zeta SKY R7 - Zeta SKY R7 SLN	95
Zeta SKY R7 - Zeta SKY R7 SLN	96
Zeta SKY HP R7 - Zeta SKY HP R7 SLN	97
Zeta SKY Hi R7 - Zeta SKY Hi R7 SLN	99
Zeta SKY Hi HP R7 - Zeta SKY Hi HP R7 SLN	100
Zeta SKY HP R5 - Zeta SKY HP R5 SLN	101
Noise levels	103
Configurations that are not possible	114
Installation advice	116
Water characteristics	116
Glycol mixtures	116
Minimum water content in the system	117
Installation site	118
Installations that require the use of treated coils	119
Aeraulic head losses and options available for the ventilating section	120



Zeta SKY

Zeta SKY is a large range of high efficiency chillers and reversible heat pumps featuring hermetic scroll compressors and an air source, suitable for both comfort and process applications. Chiller versions are designed for the production of chilled water at temperatures ranging between -8°C up to 20°C, with outside temperature from -20°C up to 48°C. Heat pump versions are designed for the production of hot water up to 60°C, and operate with outside temperature down to -15°C. Versions featuring a variable speed inverter compressor are designed to maximise seasonal efficiency. The entire range is characterised by high compactness and a reduced refrigerant charge. Zeta SKY uses low GWP refrigerants that have a low environmental impact.

REFRIGERANT

Chiller models from the Zeta Sky series are available with refrigerant R32.

Heat pump models from the Zeta Sky series are available with refrigerant R32 or R454B.

Acronym "R7" indicates the need to use refrigerant R32 and it shows that the refrigerant has a GWP level below 700.

Acronym "R5" indicates the need to use refrigerant R454B and it shows that the refrigerant has a GWP level below 500.

Refrigerant R32 (GWP=677*)

The refrigerant consists in pure gas.

R32 is classified as a Group 1 fluid under PED.

It is also classified as A2L under the ASHRAE Standard 34, i.e.

- non-toxic;
- mildly flammable.

Refrigerant R454B (GWP=466*)

The refrigerant consists in a blend of R32 (69%) and R1234yf (31%), with limited temperature glide.

R454B is classified as a Group 1 fluid under PED.

It is also classified as A2L under the ASHRAE Standard 34, i.e.

- non-toxic;
- mildly flammable.

The excellent GWP value may be an advantage in projects where:

- min. targets are adopted for the containment of the environmental footprint;
- it is possible to receive incentives or other benefits that are applicable in some countries or are connected to specific plant design criteria.

This also goes to the benefit of unit installation, commissioning and maintenance as it reduces the overall management costs.

(*) GWP (AR5), pursuant to IPCC V, evaluated over a span of 100 years.

STRUCTURE

The structure of the unit is made of galvanized sheet-iron coated with polyester powder in RAL 5017/7035 at 180°C, which makes it highly resistant to weather conditions.

The structure is a load-bearing frame, with removable panning lined with sound absorbing expanded polyurethane matting.

COMPRESSORS

Zeta SKY R7 - Zeta SKY HP R7 - Zeta SKY HP R5

The compressors are hermetic orbiting scroll scrolls connected in tandem, in one or two circuits. They are provided with thermal overload protection by internal Klixon® or external Kriwan® module (depending on the model) and with oil equalization line. All the compressors are fitted as standard with crankcase heater.

The compressors are enclosed in a dedicated technical compartment, which can be accessed by removing the panning to allow maintenance operations to be carried out even with units running.

Zeta SKY Hi R7 - Zeta SKY Hi HP R7

Depending on the model, there are the following compressor configurations:

models with just one compressor (x.1) use a single modulating compressor

models with two compressors (x.2) use one modulating compressor connected in tandem with one ON/OFF compressor

The modulating compressors are hermetic scroll compressors with permanent-magnet brushless motor and are fitted with oil level sight glass.

The speed of the modulating compressor is varied, depending on the total heat load, roughly between 30 and 105 rps. 30rps and 105rps Its nominal capacity relates to a speed of 90rps. 90rps.

The speed of rotation of the compressor is variable in the range 1.800÷6.300 rpm.

The modulating compressors are controlled through DC inverter. This also has the following functions:

- management of acceleration and deceleration ramps
- management of the operating envelope of the modulating compressor
- management of the alarms and safety devices of the modulating compressor

The use of a modulating compressor allows the total inrush current to be reduced because it is always started with an acceleration ramp. For models with two or three compressors, the starting of the ON/OFF compressors will always take place with the modulating compressor running at low speed, again in order to reduce the inrush current of the unit to a minimum.

The ON/OFF compressors are hermetic orbiting spiral scroll compressors and are fitted with oil level sight glass. For units with two compressors, there is also an oil equalization line.

SOURCE-SIDE HEAT EXCHANGER

(for chiller unit)

The exchangers are made with microchannel aluminium coils.

Thanks to continuous research in the alloys field, and sophisticated production methods, microchannel coils are made using specific aluminium alloys for the tubes and for the fins. This allows the effects of galvanic corrosion to be drastically reduced to always ensure protection of the tubes that confine the refrigerant. Tubes and fins are also subjected to SiFLUX coating processes (or equivalent) or have zinc added to further increase their corrosion resistance.

The use of microchannel coils, as opposed to conventional copper/aluminium coils, reduces the total weight of the unit and reduces the refrigerant charge.

Options are available for installation in environments with a particularly aggressive atmosphere or in coastal or highly industrialized areas. See section: "Description of accessories".

(for HP units)

The exchangers are made with finned pack coils with copper tubes and aluminium fins.

The coils have an increased fin pitch to reduce frost formation and to facilitate the outflow of condensed water during defrosting.

Options are available for installation in environments with a particularly aggressive atmosphere or in coastal or highly industrialized areas. See section: "Description of accessories".

FANS

The fans are axial fans, directly coupled to a 6-pole electric motor, with integrated thermal overload protection (Klixon®) and IP 54 protection rating.

The fan includes the shroud, designed to optimize its efficiency and reduce noise emission to a minimum, and the safety guard.

The control manages the speed of the fans through a phase cutting speed adjuster, in order to optimize the operating conditions and efficiency of the unit.

The fan speed regulator is supplied standardly.

This control also has the effect of reducing the noise level of the unit: in fact, the typical conditions under which the control will be modulating the speed of the fans are those of the night, spring and autumn.

For units equipped with EC fans (option), the same function is carried out using the electronically commutated motor of the fans.

USER-SIDE HEAT EXCHANGER

The exchanger is a braze-welded stainless steel plate heat exchanger, insulated with a shroud of closed-cell insulating material.

The exchanger is also equipped with thermostat-controlled anti-freeze heater to protect it from ice formation when the unit is not running.

REFRIGERANT CIRCUIT

Zeta SKY R7 - Zeta SKY HP R7 - Zeta SKY HP R5

Each refrigerant circuit of the basic unit comprises:

- valve on the liquid line
- 4-way reversing valve (applies to HP versions only)
- valve on delivery line (applies to HP versions only)
- liquid receiver
- charging valves
- liquid sight glass
- Weld-on filter drier
- thermostatic expansion valve with pressure equalization
- high and low pressure switches

The pipes of the circuit and the exchanger are insulated with extruded closed-cell expanded elastomer.

As an accessory, all the units can be fitted with an electronic expansion valve that allows machine stability to be reached more quickly and better superheating control than the mechanical expansion valve, to maximize the use of the evaporator in all load conditions.

Zeta SKY Hi R7 - Zeta SKY Hi HP R7

Each refrigerant circuit of the basic unit comprises:

- valve on the liquid line
- 4-way reversing valve (applies to HP versions only)
- valve on delivery line (applies to HP versions only)
- liquid receiver
- charging valves
- liquid sight glass
- Weld-on filter drier
- electronically-controlled thermostatic expansion valve
- high and low pressure switches

The pipes of the circuit and the exchanger are insulated with extruded closed-cell expanded elastomer.

ELECTRICAL CONTROL PANEL

The electrical control panel is made in a painted galvanized sheet-iron box with forced ventilation and IP54 protection rating.

The electrical control panel of the basic unit comprises:

- main disconnect switch
- automatic circuit breakers for compressors with fixed calibration
- fuses for protecting the fans and auxiliary circuits
- fan contactors
- phase-cutting fan speed adjuster
- thermal magnetic circuit breakers for pumps (if present)
- phase monitor
- potential-free general alarm contacts
- single potential free operating contacts for compressors, fans and pumps (when present)
- digital input for general ON/OFF
- summer/winter selection by digital input (only for HP units)
- external air temperature probe
- microprocessor controller with display accessible from the outside

All the electrical cables inside the panel are numbered and the terminal board dedicated to the customer's connections is coloured orange so that it can be quickly identified in the panel.

Zeta SKY R7 - Zeta SKY HP R7 - Zeta SKY HP R5:

- The power supply of the unit is 400V/3~+N/50Hz for the following models:

from size 3.2 up to size 8.2

The power supply of the unit is 400V/3~/50Hz for the following models:

- from size 9.2 up to size 16.4

Zeta SKY Hi R7 - Zeta SKY Hi HP R7

- The power supply of the unit is 400V/3~+N/50Hz for the following models:

from size 3.1 up to size 8.2

The power supply of the unit is 400V/3~/50Hz for the following models:

- from size 10.2 up to size 12.2

CONTROL BLUETHINK

Zeta SKY R7 - Zeta SKY HP R7 - Zeta SKY HP R5:

For further details on available functions and on displayed information, refer to the specific documentation of the controller.

By default, the serial connections present as standard are enabled only for reading from BMS. Enabling of writing from BMS is to be requested when ordering.

The unit is supplied as standard with parametric control. The advanced control can be requested as accessory.

Main controller functions parametric

The control allows the following functions:

- water temperature adjustment, with control of the water entering the user-side heat exchanger
- freeze protection
- compressor timings
- automatic rotation of compressor starting sequence
- recording of the alarm log
- RS485 serial port with Modbus protocol
- digital input for general ON/OFF
- digital input for Summer/Winter selection (only for HP units)

Main controller functions advanced

The control allows the following functions:

- water temperature adjustment, with control of the water entering the user-side heat exchanger
- freeze protection
- compressor timings
- automatic rotation of compressor starting sequence
- recording of the log of all machine inputs, outputs and states
- automatic rotation of compressor starting sequence
- recording of the alarm log
- RS485 serial port with Modbus protocol
- Ethernet serial port with Modbus protocol and integrated web server preloaded web page
- digital input for general ON/OFF
- digital input for Summer/Winter selection (only for HP units)

For further details on available functions and on displayed information, refer to the specific documentation of the controller.

By default, the serial connections present as standard are enabled only for reading from BMS. Enabling of writing from BMS is to be requested when ordering.

Zeta SKY Hi R7 - Zeta SKY Hi HP R7

The unit is supplied as standard with an advanced controller.

The control allows the following functions:

- water temperature adjustment, with outgoing water control
- freeze protection
- compressor timings
- automatic rotation of compressor starting sequence
- recording of the log of all machine inputs, outputs and states
- automatic rotation of compressor starting sequence
- recording of the alarm log
- RS485 serial port with Modbus protocol
- Ethernet serial port with Modbus protocol and integrated web server preloaded web page
- digital input for general ON/OFF
- digital input for Summer/Winter selection

For further details on available functions and on displayed information, refer to the specific documentation of the controller.

By default, the serial connections present as standard are enabled only for reading from BMS. Enabling of writing from BMS is to be requested when ordering.

Main functions of the webserver (only for units with advanced control)

As standard, the Bluethink controller integrates a webserver with a preloaded web page that is accessed via password.

The web page allows the following functions to be carried out (some of these are available only for users with advanced level rights):

- display of the main functions of the unit such as unit serial n°, size, refrigerant
- display of the general status of the machine: water inlet and outlet temperatures, external air temperature, mode (chiller or heat pump), evaporating and condensing pressures, suction and discharge temperatures
- display of the status of compressors, pumps, expansion valves
- display in real time of the graphs of the main quantities
- display of the graphs of logged quantities
- display of alarm log
- management of users on several levels
- remote ON/OFF
- remote set point change
- remote time band change
- remote summer winter mode selection (only for HP units)

Human-Machine Interface

The control has a graphic display that allows the following information to be displayed:

- water inlet and outlet temperature
- set temperature and differential set points
- description of alarms
- hour meter of operation and number of start-ups of the unit, the compressors and the pumps (if present)
- high and low pressure values, and relevant condensing and evaporating temperatures
- external air temperature
- superheating at compressor suction.

Management of defrost cycles

(only for HP units)

For defrost management, the control of the unit uses a sliding intervention threshold, depending on the pressures inside the unit and the external air temperature. By putting together all this information, the control can identify the presence of ice on the coil and activates the defrosting sequence only when necessary, so as to maximize the energy efficiency of the unit.

Sliding management of the defrost threshold ensures that, as the absolute humidity of outdoor air decreases, the frequency of the defrost cycles gradually decreases because they are carried out only when the ice formed on the coil actually penalizes performance.

The defrost cycle is fully automatic: during the initial stage, a defrost is carried out by cycle reversal with the fans stopped. As soon as the frost on the coil has molten to a suitable level, the unit resumes operation in heat pump mode.

OPTIONS

/HWT: High water temperature on user side

This option is only available for Zeta SKY model HP R7.

The HWT option is designed to expand the work range of the unit.

The BlueThink technology is used to check the output temperature of the compressor, which enables expanding the operating limits and generating hot water up to 60°C. The check is performed using the electronically-controlled expansion valve.

/HAT: unit for high external air temperatures

The HAT option is designed to expand the work range of the unit.

/DC: unit with total recovery condenser

In addition to the set-up of a chiller only unit, /DC units comprise:

- a heat recovery condenser for recovering 100% of the condensation heat on each refrigerant circuit. The exchanger is a brazed plate heat exchanger; for dual circuit units, the heat exchangers are to be manifolded outside the unit (by the customer)
- temperature probe at the inlet of the heat recovery heat exchanger; for dual circuit units, the probe is supplied with the unit and is to be positioned on the heat exchanger inlet manifold (by the customer)
- liquid receiver for each refrigerant circuit with system for emptying the refrigerant from the condensing coil
- potential free contact in the electrical control panel for activation of recovery.

When required by the system, through the closing of a contact, the control automatically manages activation of recovery. Recovery management is carried out through a control on the temperature of the return water. The control also automatically manages safety deactivation of recovery if the condensing pressure becomes too high, and changes to using the condensing coils.

This option is not available for /HP units

It is mandatory to select the advanced control (accessory).

/DS: unit with desuperheater

/DS units comprise (for each refrigerant circuit) an exchanger for condensation heat recovery of up to 20% (depending on size, version and operating conditions), placed in series with the condensing coil. The exchanger is a braze-welded plate heat exchanger. For multi-circuit units, the exchangers are to be manifolded outside the unit (by the customer).

The installation of the desuperheater circuit pump is the responsibility of the customer.

The unit does not control external pumps and/or sensors on the desuperheater circuit.

The desuperheater can be used during operation in cooling mode. However, it can also be used in heating mode on condition that the following measures are taken:

- a valve (either 2- or 3-way) must be installed on the desuperheater water circuit;
- the valve must be monitored using a temperature control system;
- the valve must be operated to regulate the temperature of the input water into the desuperheater = IWTds.

First, enter the unit heating setpoint, which corresponds to the temperature of water delivered to the heating unit=LWTu_Heating. Then set the condition below:

- $IWTds > LWTu_Heating + 10 [K]$

The valve, the control systems and their installation, setup operations, etc. are the responsibility of the client. If heat recovery is not required during operation in heat pump mode, or where the above requirements are not met, the water circuit of the desuperheater must be shut off.

Desuperheater operation in heat pump mode reduces the heating capacity transferred from the unit to the user's hydronic circuit. When a desuperheater is fitted, irrespective of it running in either cooling or heating mode, the max. temperature of water delivered to the heating unit (LWTu_Heating) is reduced, as described in the section "Operating limits".

An illustrative graph is shown below in which, as the ambient temperature changes, (T_{air}) and as the temperature of the water leaving the heat recovery heat exchanger changes, ($T_{w,out DS}$), the percentage of recovered heat is shown as an indication (Recovery ratio).

Condensation heat recovery is a function of size, version and operating conditions.

The percentage of recovered heat is calculated as the ratio between recovered heat flow to the desuperheater and the heat flow to the condenser under nominal conditions, therefore evaporator inlet-outlet water temperature 12-7°C.

In the following graph, a constant temperature delta of 5°C between water inlet and outlet at the heat recovery heat exchanger has been considered.

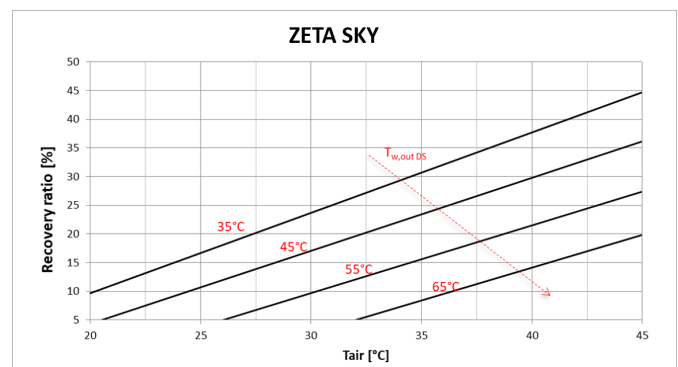

/LN: silenced unit

In the unit with /LN option, all the compressors are enclosed in a compartment that is fully soundproofed with sound absorbing material and soundproofing material.

/SLN: super low noise unit

Unit versions SLN are characterised by the use of a soundproofed compressor compartment, fans with a speed adjuster, and a reduced air flow rate. The speed reduction of the fans is such that, under nominal operating conditions, the air flow rate and noise level are lower than those of the basic version of the unit.

In any case, the use of the speed adjuster to reduce the air flow rate allows rotation of the fans at maximum speed when external air temperature conditions are particularly critical and therefore guarantees the same operating limits as the high efficiency version.

Also, for SLN/HP version units working in heat pump mode, the fans always operate at 100% speed and therefore guarantee the same performance levels as the high efficiency versions.

HYDRAULIC MODULES

All units can be fitted with hydraulic module in various configurations:

- /1P: hydraulic module with one pump
- /2P: hydraulic module with two pumps
- /1PS: hydraulic module with one pump and buffer tank
- /2PS: hydraulic module with two pumps and buffer tank

The following are also available:

- modules /1Pr, /2Pr, /1PrS e /2PrS that have pumps with reduced available discharge head
- modules /1PG, /2PG, /1PGS and /2PGS that have pumps suitable for operating with glycol up to 40%

Hydraulic modules with one pump have:

- one pump
- an expansion vessel

Hydraulic modules with two pumps have:

- two pumps
- a check valve on the delivery side of each pump
- an expansion vessel

In the version with 2 pumps, these are always with one on standby while the other is working. Switching over between the pumps is automatic and is done by time (to balance the hours of operation of each one) or in the event of failure.

Hydraulic modules with tank also have:

- a gate valve at the inlet of the pump or the suction manifold
- a tank with drain valve and air valve

Refer to the table of configurations that are not possible to check for availability of specific set-ups.

All the hydraulic circuit components are fully insulated, except for:

- drain valves
- venting valves
- tank plugs
- safety valves
- expansion vessel
- probe pockets

CONTROLS AND SAFETY DEVICES

All the units are fitted with the following control and safety components:

- user-side water temperature probe
- antifreeze probe on the user side heat exchanger
- high pressure switch with manual reset
- low pressure safety device with automatic reset, for a limited number of occurrences, managed by the controller
- compressor overtemperature protection
- fan overtemperature protection
- differential flow switch

TESTING

All the units are factory-tested and supplied complete with oil and refrigerant.

PACKAGING

The unit is made and shipped on a wooden pallet that allows the unit to be handled using a forklift truck.

The unit is wrapped in a protective transparent polyethylene stretch film.

CERTIFICATIONS AND REFERENCE STANDARDS

Responsibilities and obligations exclusive to the installer:

The manufacturer has implemented and keeps the Management Systems listed below and it is certified against them:

- Quality Management System according to standard UNI EN ISO 9000;
- Environmental Management System according to standard UNI EN ISO 14000;
- Health and Safety Management System according to standard BS OHSAS 18000 (as converted into UNI EN ISO 45000).

These management systems ensure that the company puts in place any and all actions and initiatives to define and monitor the standards defined by its Management, which are stated in its Quality, Environmental and Safety policies.

To meet the safety requirements, the unit was designed and manufactured in compliance with the directives and product regulations below:

- PED Directive: safety criteria to be followed when designing pressure equipment;
- Machinery Directive: safety criteria to be followed when designing machinery;
- Low Voltage Directive: safety criteria to be followed when designing electrical machine parts;
- Electromagnetic Compatibility Directive: electromagnetic compatibility criteria to be followed when designing electrical machine parts;
- WEEE Directive: criteria for product management at the end of its life cycle as waste with a view to environmental protection.

The units are manufactured, tested and checked with reference to the European standards specified in the Declaration of CE Conformity, in accordance with the requirements and procedures of our Quality System.

The installation, use and storage of units featuring mildly flammable refrigerants (A2L pursuant to standard ASHRAE 34), such as R32 and R454B, must meet the European standards and regulations and the local laws, where applicable.

For further details, please refer to the "Instruction manual for operation and maintenance".

- to carry out a specific risk assessment according to the European regulations/standards above and/or the local laws in order to define the necessary measures for conformity;
- to comply with the requirements and to take the measures resulting from the outcomes of the risk assessment, pursuant to the relevant regulations and standards.

DESCRIPTION OF ACCESSORIES

Some accessories may be incompatible with each other even if not expressly indicated.

Refrigerant circuit accessories

BC Capacitive backup battery for electronic expansion valve

When the compressors stop, the controller always closes the electronic expansion valve to prevent dangerous refrigerant migration. The presence of the backup battery ensures that the electronic valve is kept in closed position even when there is no power supply

This option uses a condenser as energy storage, and not an ordinary coil. In this way, it is not affected by the memory effect of normal coils and the need for maintenance is avoided.

Applies to units with advanced controller.

BT Backup battery for electronic expansion valve

When the compressors stop, the controller always closes the electronic expansion valve to prevent dangerous refrigerant migration. The presence of the backup battery ensures that the electronic valve is kept in closed position even when there is no power supply

This option uses a condenser as energy storage, and not an ordinary coil. In this way, it is not affected by the memory effect of normal coils and the need for maintenance is avoided.

Applies to units with parametric controller.

BK Brine Kit

This accessory is compulsory if a water temperature set point lower than or equal to +3°C is used (if the unit is provided with double set point or variable set point, the lower set point is considered).

The accessory consists of increased insulation and suitable sizing and calibration of some components.

The inlet and outlet temperatures of the user-side exchanger must be given on ordering to allow correct setting of the alarm parameters and verification of the sizing of the expansion valve.

The cooling set point can then be changed by the customer in an interval that, compared to the set point given on ordering, ranges from -1K up to the allowed limit temperature.

The unit will be optimized to work at the set point temperature given on ordering. For different set points, the cooling capacity provided and the level of efficiency of the machine could decrease and move away from these conditions.

DVS Double safety valve

With this accessory, instead of each individual safety valve per circuit, there is a "candelabrum" with two safety valves and a diverter valve for choosing the valve in operation. This allows the safety valves to be replaced without having to drain the machine and without having to stop it.

MAFR Pressure gauges

The operating pressures of each circuit of the unit can be displayed on the control by accessing the relevant screens. Also, the machine can be fitted with pressure gauges (two for each circuit) installed in a clearly visible position. These allow reading in real time of the working pressures of the refrigerant gas on the low pressure side and on the high pressure side of each refrigerant circuit.

RG Fan speed adjuster

The control manages the speed of the fans through a phase cutting speed adjuster, in order to optimize the operating conditions and efficiency of the unit.

This control also has the effect of reducing the noise level of the unit: in fact, the typical conditions under which the control will be modulating the speed of the fans are those of the night, spring and autumn.

For units equipped with EC fans, the same function is carried out using the electronically commutated motor of the fans and is supplied as standard.

RIC Liquid receiver

The adoption of this accessory always guarantees correct feeding of the expansion valve even when the unit is subjected to wide external air temperature ranges.

This accessory is standard on DC and HP units.

RUB Compressor suction and delivery valves

The valves situated on the delivery side and on the suction side of the compressors allow the compressor to be isolated from the rest of the refrigerant circuit, so making the maintenance operations quicker and less invasive

VS Liquid line solenoid valve

This accessory prevents refrigerant migration that could damage the compressor on starting. This option is standard in HP units.

VTE Electronic expansion valve

The use of this component is particularly advisable on units operating in very variable heat load or operating mode conditions, as in the case of joint management of air conditioning and high temperature water production. The use of an electronic thermostatic valve allows you to:

- maximize heat exchange at the evaporator
- minimize response times to changes in load and operating conditions
- optimize control of overheating
- ensure maximum energy efficiency

This option is standard in units Zeta Sky Hi HP R7.

RPP Refrigerant leak detector with automatic pump down

With this accessory, a refrigerant leak detector is placed inside each compressor compartment. Detection of a refrigerant leak is managed by the control through a specific alarm and display of a specific icon on the display of the control. For all the circuits of the unit, the alarm also starts the machine stopping procedure with pump down, confining all the refrigerant in the coils.

The accessory includes the capacitive backup battery.

RPR Refrigerant leak detector

With this accessory, a refrigerant leak detector is placed inside each compressor compartment.

For units supplied with advanced controller, the detection of a refrigerant leak is managed by the controller through a specific alarm and display of a specific icon on the display of the controller. This alarm stops the unit.

For units supplied with parametric controller, a LED light goes on outside the electrical panel to warn about the leak. Provision is made for a potential-free contact to trigger the alarm.

Fan accessories

VEC EC fans

With this accessory, EC fans, with electronically commutated brushless motor, are used for the ventilating section. These guarantee very high efficiency levels for all working conditions and allow a 15% saving on the power absorbed by each fan working at full capacity.

Also, through a 0-10V analogue signal sent to each fan, the microprocessor carries out condensation/evaporation control by continuous adjustment of the air flow rate as the external air temperature changes, with a further reduction in electrical absorption and noise emission.

For further details, see the dedicated chapter: "Aeraulic head losses and options available for the fan section".

VEM Oversize EC fans

The increased EC fans allow to obtain the same benefits as EC fans and in addition allow to have a residual useful head of about 100Pa.

For further details, see the dedicated chapter: "Aeraulic head losses and options available for the fan section".

RECP Pressure recuperator

Normally, the air ejected by the fan has a high speed and this manifests itself as kinetic energy that is dissipated into the environment.

The pressure recuperator is a passive element situated on the ejection duct of each individual fan designed to allow better conversion of kinetic energy into static pressure, which manifests itself as a higher pressure generated by the fan.

This higher pressure can have at least two possible applications:

- For the same fan speed, the pressure recuperator allows an increase of about 50Pa in the available pressure of the ventilating section to be obtained. This can be useful for overcoming the head losses that may be present in specific installations. The increase in available pressure is to be considered in addition to the increase that can already be obtained with the application of oversize EC fans
- for the same pressure differential on the air, the pressure recuperator allows the same air flow rate to be obtained with a lower number of revolutions of the fan.

To allow optimization of the performance of the accessory, combination with the speed adjuster or EC fans is necessary. In this last case, the higher efficiency of the EC fans (especially when operating at low speed) is added to the performance improvement generated by the pressure recuperator.

The accessory is supplied separately from the unit on one or more pallets and it must compulsorily be installed (by the customer) before the first start-up of the machine.

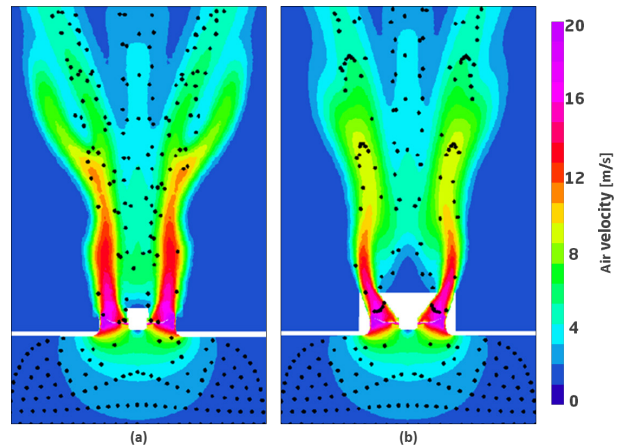
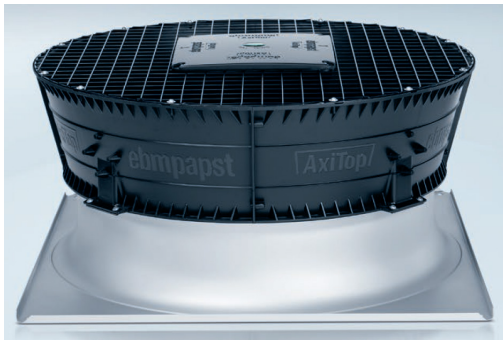

(a) fan only;

(b) fan with pressure recuperator

Hydraulic circuit accessories

CORM Connection for manual filling

This accessory allows the system filling procedure to be carried out directly from the unit: on the fan holder cover, there is a 1" filling valve and a 1/2" air valve. Near the filling valve, there is also a pressure gauge for displaying the pressure in the hydraulic circuit. This accessory can be combined only with units provided with tank.

As an alternative to the differential pressure switch (standard flow sensor), it is possible to request the paddle flow switch as accessory. This detects when there is no water flow to the user-side exchanger and sends a signal to the control of the unit that will stop the compressors to prevent damage to the exchangers.

Application of this accessory is compulsory for units that use non-glycol water and work with a yearly cycle where external air temperatures are zero or below.

The flow switch is supplied loose (installation by the customer) and replaces the water differential pressure switch (standard).

SID Hydraulically disconnected tank

This accessory is mandatory on units fitted with the "Automatic management of domestic hot water" accessory and a hydraulic module with tank (1PxS or 2PxS).

The tank fitted in the unit will have an inlet and outlet, flush with the machine profile, and will be disconnected from the remaining hydraulic circuit. This will allow correct enabling of the 3-way valve for domestic hot water management, thus avoiding going through the buffer tank during domestic hot water production.

IVPO Soundproofed pump compartment

With this accessory, the motor and the impeller of the pumps are enclosed in a compartment that is fully soundproofed with sound absorbing material and soundproofing material.

RA Antifreeze heater

These electric heaters are fitted on the pumps and in the tank (depending on the configuration of the machine) to prevent damage to the hydraulic components due to ice formation during periods when the machine is inactive.

Based on normal operating conditions and the percentage of glycol in the system, an appropriate "antifreeze alarm" temperature is set in the control. When a temperature that is 1K higher than the antifreeze alarm threshold is detected at the outlet from the exchanger, the pump (if present) and the antifreeze heaters are switched on. If the temperature of the outgoing water reaches the antifreeze alarm threshold, the compressors are stopped, keeping the heaters and the pumps active, and the general alarm contact of the machine is activated.

The antifreeze heater is only featured as a standard component on the user-side heat exchanger.

VSIW Water-side safety valve

With this accessory, a safety valve is inserted in the hydraulic circuit of the unit: when the calibration pressure is reached, the valve opens and, by discharging (to be routed by the customer), prevents the system pressure from reaching limits that are dangerous for the components present in the system. The valves have positive action, that is, performance is guaranteed even if the diaphragm deteriorates or breaks.

RINT Additional heaters (on user side)

The accessory requires an additional immersed heater to be installed directly in the tank of the hydraulic module.

The additional heater is activated only when:

- the unit is in heat pump mode
- the external air temperature is below a settable threshold (service parameter)
- the tank inlet water temperature is below a settable threshold (service parameter)

The additional heaters can have a different capacities depending on the machine model, and they can be managed with stepped control (up to 4 steps).

V3 Three-way valve for domestic hot water management

This is a three-way on-off valve, complete with servo control. The unit controller can manage two separate hydraulic circuits through this valve: one for comfort and one for domestic hot water production.

The valve and the servo control are for indoor installation and they require the ambient temperature not to drop below -10°C.

Accessory supplied loose. Installation by the customer.

FLUS Flow switch (instead of the water differential pressure switch)

As an alternative to the differential pressure switch (standard flow sensor), it is possible to request the paddle flow switch as accessory. This detects when there is no water flow to the user-side exchanger and sends a signal to the control of the unit that will stop the compressors to prevent damage to the exchangers.

Application of this accessory is compulsory for units that use non-glycol water and work with a yearly cycle where external air temperatures are zero or below.

The flow switch is supplied loose (installation by the customer) and replaces the water differential pressure switch (standard).

Flowzer options

Our range of Flowzer options offers flexible and scalable solutions to set the speed of pumps in the system with a view to optimising and reducing energy consumption. Different types of control modes are offered based on the system and application type:

- FLOWZER VP - Inverter for manual pump adjustment
- FLOWZER VD - control of available pump discharge head for variable flow systems without monitoring the flow rate limits;
- FLOWZER VDE - flow rate control to keep the flow rate constant as the external working conditions of the system change;
- FLOWZER VDT - flow rate control with constant TD (difference between input and output temperature in the heat exchanger on the user side) in variable flow pumps, without monitoring the flow rate limits;
- FLOWZER VFPP - automatic management of variable flow rate in systems with one single primary circuit and a bypass valve;
- FLOWZER VPS - automatic management of variable flow rate, including balancing of flow rates between primary and secondary circuits;
- flowzer vps with TD-based control - automatic management of variable flow rate, including control with constant TD (difference between input and output temperature in the heat exchanger on the user side) in systems featuring both the primary and secondary circuits.

The tables below summarise the main system diagrams and show the application type and advantages/disadvantages offered by each solution. Each individual option is illustrated and explained individually in the next pages.

The hydraulic diagrams in this document are for exemplification purposes only and their main function is to help the reader understand the type of machines and devices the controller can manage. For a more technical evaluation of the system, please refer to the dedicated manual.

Constant flow system			
	Application	Advantages	Disadvantages
Flowzer VP	Ideal for constant flow systems The option is given to set two different speeds: one for heating and one for cooling mode or one for chiller and one for FC mode. This solution replaces the 2-way regulating valve.	<ul style="list-style-type: none"> - Increased efficiency: increased "REAL" EER of the unit installed, considering the power consumption of the pumps in real installation conditions and in real operating conditions. - Reduced installation times and costs: quick setup of water flow using the display. 	This solution doesn't allow to save energy in the pump under part load conditions, due to the possibility to only set two frequency values in the inverter.
Flowzer VDE	Ideal for constant flow systems to keep the water flow to the heat exchanger constant under all conditions	<ul style="list-style-type: none"> - Plug&Play: provides for easy and flexible implementation as it is not supplied with options to be fitted therefore allows for quick commissioning. 	This solution is less efficient as losses in the heat exchanger are kept constant under all conditions (including in cases when they may be reduced).

FLOWZER VP

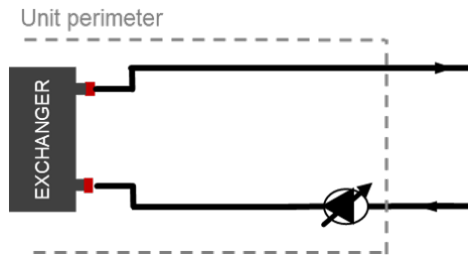

FLOWZER VDE

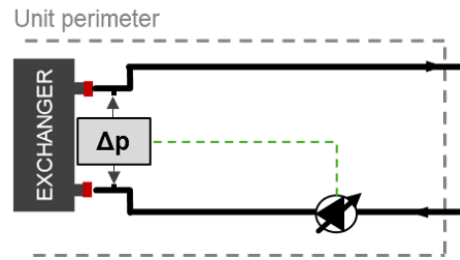

Variable flow system featuring primary and secondary circuits

	Application	Advantages	Disadvantages
Flowzer VPS	Ideal for all systems featuring a primary and a secondary circuit divided by a hydraulic bypass branch	<ul style="list-style-type: none"> - Energy saving: the energy consumption during pumping operations can be cut down to 55% if compared with a traditional system - Enhanced comfort: correct balancing between primary and secondary loop 	Only recommended in systems featuring a primary and a secondary circuit divided by a bypass pipe; not flexible for other applications
Flowzer VDT	Ideal for systems featuring similar users or users with similar operating conditions. It is recommended in structured systems in which the client has third-party systems to control the min. and max. flow rate.	<ul style="list-style-type: none"> - Plug&Play: provides for easy and flexible implementation as it is not supplied with options to be fitted and for quick commissioning. 	Risk of over- or underflow for some of the users in the secondary circuit if they have different operating conditions (same temperature difference). A control is required by third-party equipment to ensure compliance with the unit flow limits.
FLOWZER VPS with TD-based control	Ideal for systems featuring similar users or users with similar operating conditions. Ideal for systems featuring a primary and a secondary circuits physically divided from the heat exchanger or a tank with multiple connections.	<ul style="list-style-type: none"> - Plug&Play: provides for easy and flexible implementation as it is not supplied with options to be fitted and for quick commissioning. 	Risk of over- or underflow for some of the users in the secondary circuit if their temperature difference is not the same due to the existing operating conditions

FLOWZER VPS

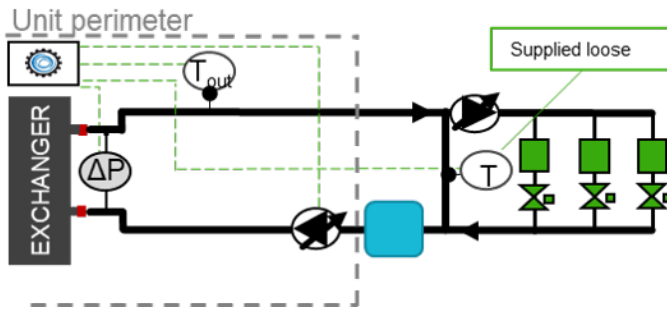

FLOWZER VDT

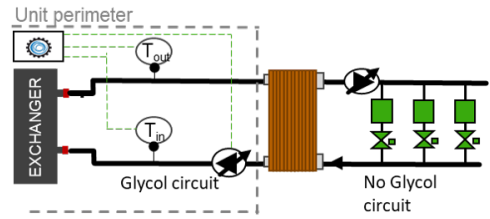
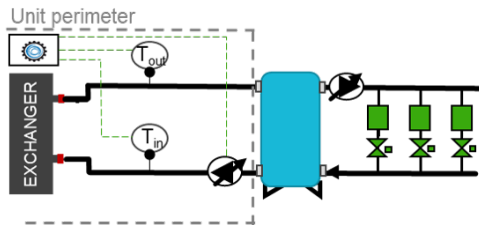

FLOWZER VPS with DT-based control

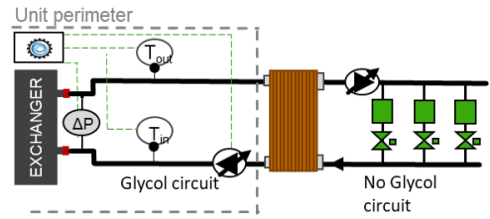
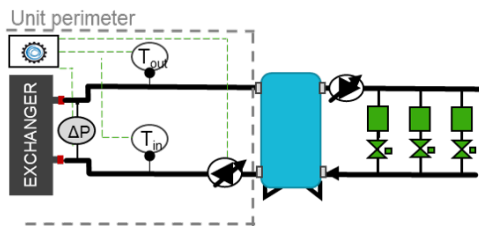

Variable flow system featuring primary circuit only

	Application	Advantages	Disadvantages
Flowzer VFPP	Ideal for new systems intended to reduce installation costs	- Energy saving: the energy consumption during pumping operations can be cut down to 50% if compared with a traditional system Lower CAPEX thanks to reduced installation costs and smaller number of components (one pump less)	Requires some testing to correctly set the pressure available in the system and to correctly position the two transducers, based on the system layout and devices.
Flowzer VD	Ideal for systems fitted with changing users according to the season. Ideal for industrial processes, such as injection moulding, in order for each terminal to operate with the correct discharge head. It is recommended in structured systems in which the client has third-party systems to control the min. and max. flow rate.	- Plug&Play: provides for easy and flexible implementation as it is not supplied with options to be fitted therefore allows for quick commissioning.	A control is required by third-party equipment to ensure compliance with the unit flow limits.

Flowzer VFPP

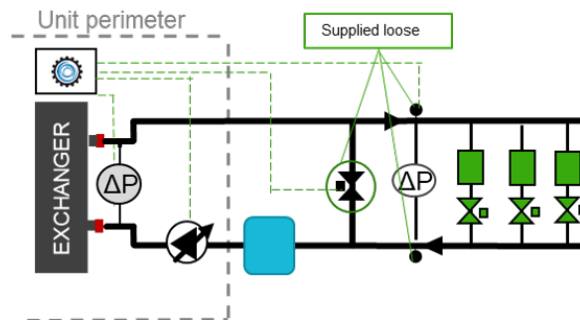

Flowzer VD

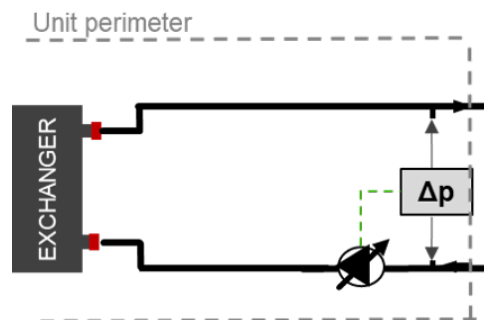

FVP FLOWZER VP - Inverter for manual pump adjustment

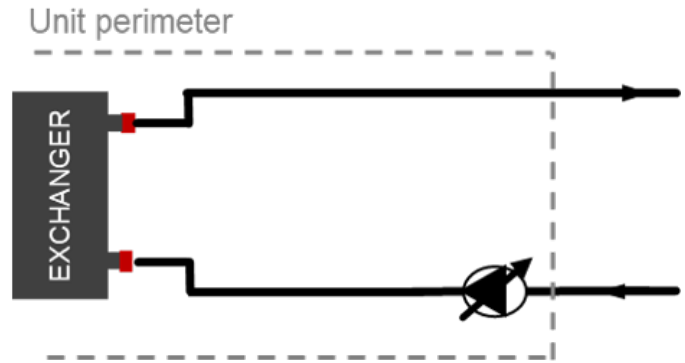

The accessory consists of inserting an inverter in the machine to manually adjust the speed of the pump (or pumps) in order to calibrate the pump flow rate on the head losses of the system. This accessory is to be combined with one of the integrated hydraulic modules that can be selected for the unit. It is mandatory to select the advanced control (accessory).

Units equipped with integrated hydraulic module allow a certain level of available discharge head (point A) to be obtained under nominal flow rate conditions Q_d .

But the actual head loss level of the system (e.g. characteristic curve R') normally causes the pump to find a different equilibrium point (point B), with a flow rate Q_r higher than Q_d .

In this condition, in addition to having a different flow from the nominal one (therefore also a different temperature jump), there is also a greater absorption of electric power from the pump itself.

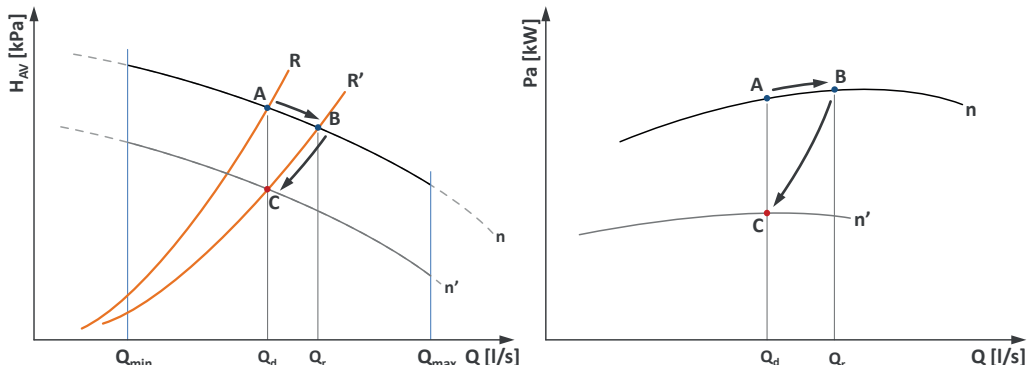

The use of the Flowzer allows the pump speed to be set manually (e.g. at speed n' instead of n) to obtain the design water flow rate and thermal gradient (point C). Once the adjustment procedure has been carried out, the pump will always work at a fixed flow rate.

The adoption of the VP Flowzer allows to considerably reduce the electrical power consumption of the pump with a consequent energy saving. By way of example, a reduction in the flow rate of 10% leads to a reduction in power consumption of around 27%.

For the freecooling units the Flowzer VP is able to manage two different speeds of the pump automatically compensating the pressure drops of the water coil.

FVD FLOWZER VD - control of available pump discharge head for variable flow systems without monitoring the flow rate limits;

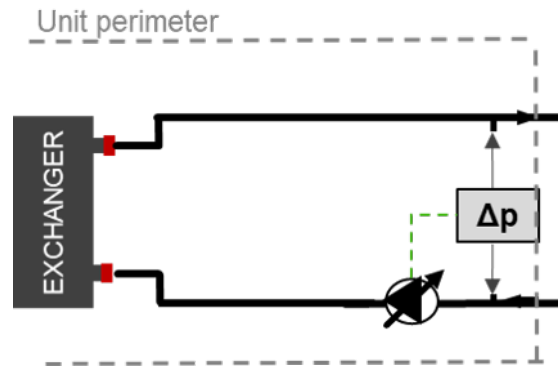

Flowzer VD requires two pressure transducers to be installed in the machine. Through these transducers, the inverter can gauge the actual pressure at the ends of the system and it can automatically adapt the pump speed to obtain a set available discharge head value. Flowzer VD must be combined with Flowzer VP. This accessory therefore allows a constant pressure system to be achieved.

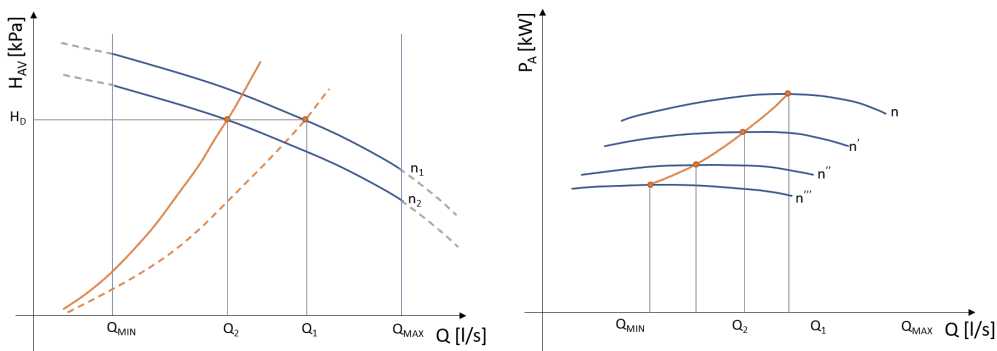

With the Flowzer VD, the customer can set, directly on the display, the available discharge head value (H_d) that the unit must maintain. As can be seen from the graph as the user request decreases, the resistant curve of the plant moves to the left, consequently the inverter reduces the speed of the pump in order to maintain the useful head necessary for the unit. With this system a significant reduction in electrical power is achieved. The customer will have to check that, in minimum flow rate conditions (that is, with the maximum number of user points closed), this is always higher than or equal to the minimum flow rate allowed by the unit.

This accessory is useful when the total head losses of the circuit are slightly variable or when they change depending on the seasons (for example, some user points are active only during summer operation and not during winter operation).

The use of this accessory also allows the pump speed to be adapted to possible fouling of the filter on the hydraulic circuit.

The option is not compatible with the Multilogic version. Please refer to the HYZER solutions for the compatibility between variable flow systems and multi-machine systems.

FVDE FLOWZER VDE - flow rate control to keep the flow rate constant as the external working conditions of the system change;

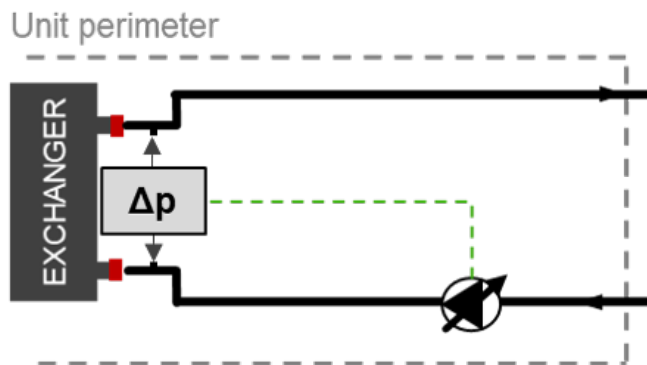

Flowzer VDE requires a differential pressure transducer to be installed in the machine. Through this transducer, the inverter can gauge the actual pressure at the ends of the heat exchanger installed in the machine and it can automatically adapt the pump speed for a constant flow value under all conditions. Flowzer VDE must be combined with Flowzer VP.

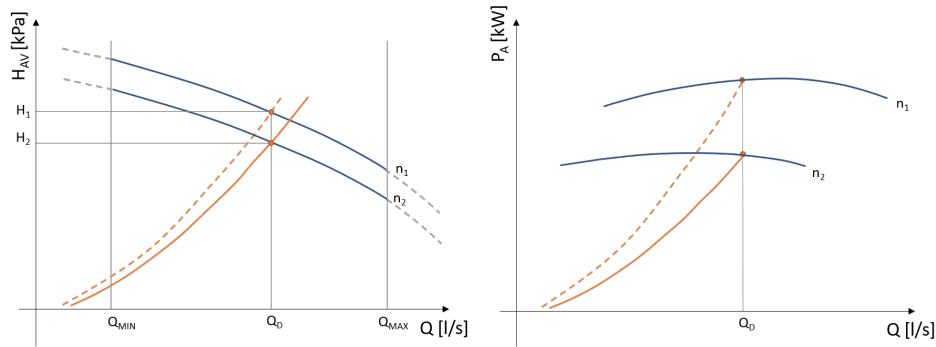

Flowzer VDE is used to automatically adjust the pump speed. As the graph shows, the inverter trips and increases the pump speed if a different condition occurs which would cause an undesired drop in the flow rate (e.g. operation of an external dry cooler). This is a more accurate solution than the VP option alone as it always provides for the water flow (Q_d) required by the design conditions.

FVDT FLOWZER VDT - flow rate control with constant TD (difference between input and output temperature in the heat exchanger on the user side) in variable flow pumps, without monitoring the flow rate limits;

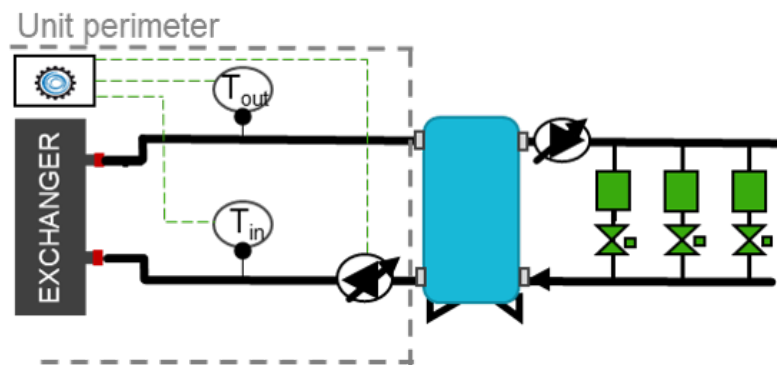

Flowzer VDT uses the temperature sensors installed at the inlet and outlet of the heat exchanger to automatically adjust the pump speed, thus keeping the T delta difference setpoint constant.

The option is not compatible with the Multilogic version. Please refer to the HYZER solutions for the compatibility between variable flow systems and multi-machine systems.

The unit must include the advanced Bluethink controller and just one heat exchanger on the user side.

With the Flowzer VDT, the customer can set, directly on the display, the available delta T value that the unit must maintain. The customer will have to check that, in minimum flow rate conditions (that is, with the maximum number of user points closed), this is always higher than or equal to the minimum flow rate allowed by the unit.

This option is specifically designed for systems in which the system users have similar operating conditions (same temperature difference).

FVVF FLOWZER VFPP - automatic management of variable flow rate in systems with one single primary circuit and a bypass valve;

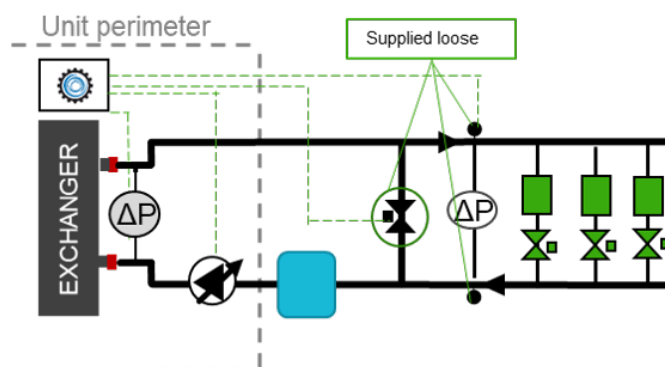

Bluethink solution for a variable flow rate system, consisting solely of a user-side primary circuit.

Flowzer VFPP includes:

- a pressure transducer installed at the ends of the user-side exchanger (Δp_e)
- a dedicated control system, installed at the factory in the electrical control panel of the unit (S_c)
- a modulating bypass valve with servo-motor supplied separately with it (V_{bp}), supplied loose (installation by the customer)
- two system pressure transducers (Δp_p) supplied separately (installation by the customer)

It is obligatory for the option to be combined with the Flowzer VP (inverter) and with one of the hydraulic modules that can be selected for the unit. The accessory is not compatible with Multilogic. Please contact our sales department for further details.

The unit must include the advanced Bluethink controller, just one heat exchanger on the user side and a minimum capacity step of 25% or less.

The option offers a complete default package to guarantee simple selection, purchasing and commissioning.

Flowzer VFPP has the advantage of:

- implementing an innovative design, which is alternative to the classic system based on fixed flow-rate primary circuit plus secondary circuit
- being ideal for new or entirely redesigned systems, especially for comfort applications
- having a variable flow system, with maximum energy saving
- simplifying the layout of the user circuit
- limiting the capex of the system
- performing a reliable check

The Flowzer VFPP system controller uses an advanced algorithm that enables prevention of unnecessary waste of energy and hunting by the inverter and the bypass valve.

The capex of the system is also reduced thanks to:

- single inverter + pumping module, integrated in the unit
- small internal footprint, due to the simplified layout

The operating principle can be summarized as follows:

- Flowzer VFPP carries out constant control of the discharge head
- the controller modulates the pump speed according to the signal detected by the system transducers Δp_p
- as the demand from the system goes down, the pump speed will be reduced.
- the pump speed can be reduced until it reaches the minimum allowed flow rate on the heat exchanger of the unit
- this flow rate is indirectly monitored through the losses detected by the differential pressure transducer Δp_e
- When the minimum allowed flow rate threshold is exceeded, the control system will open the bypass valve V_{bp} to recirculate the flow rate that is not required by the system, but is necessary to guarantee the minimum flow rate to the heat exchanger.

In the required minimum load condition (that is, with all system terminals switched off) the necessary minimum volume (V_{min}) must be ensured by the relevant tank to be installed between the unit and the separator or the bypass pipe.

The bypass valve V_{bp} is controlled through a 0-10 V signal and must therefore be installed within 30 m of the unit.

The pressure transducers of the system Δp_p provide a 4-20 mA signal and require two 1/4" female fittings. These transducers must be installed within 200 m of the unit, near the system terminal that is affected by the highest line head losses or in any case in a position where it is possible to measure an adequate pressure value.

Further details can be found in the relevant manual.

FVPS FLOWZER VPS - automatic management of variable flow rate, including balancing of flow rates between primary and secondary circuits;

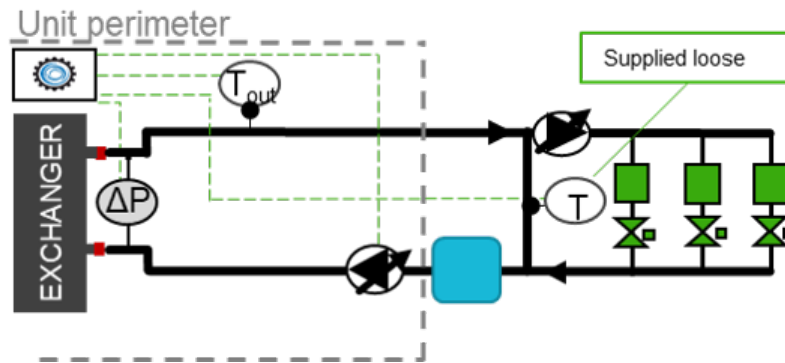

Bluethink solution for a variable flow rate system, consisting of a primary circuit plus secondary circuit. It is obligatory for the option to be combined with the Flowzer VP (inverter) and with one of the hydraulic modules that can be selected for the unit. The accessory is not compatible with Multilogic. Please contact our sales department for further details.

The unit must include the advanced BlueThink controller and just one heat exchanger on the user side. The option offers a complete default package to guarantee simple selection, purchasing and commissioning. Flowzer VPS has the advantage of:

- being ideal for renovations of existing systems, especially for comfort applications
- achieving a complete variable flow system, with maximum energy saving
- implementing a flexible design, e.g. for scalable or multi-zone systems

The maximum energy saving is achieved thanks to the advanced algorithm, which prevents hunting by the inverter and balances the pump speed and the recirculation flow rate to a minimum.

With refurbishments, the system's capex is limited to the unit and its commissioning.

The dimensions of the inverter of the unit and of the pump module can be favoured by the low design discharge head of the primary circuit.

The operating principle can be summarized as follows:

- Flowzer VPS performs a smart check of the flow rate in the primary circuit and balances it with the flow rate in the secondary circuit.
 - the system controller modulates the pump speed according to the condition detected by the system sensors T
 - if the system terminals are switched off, the flow rate of the secondary circuit will decrease; therefore the direction of flow is detected indirectly as temperature difference by the system sensors through the separator or the bypass pipe
 - The check thus contributes to reducing the speed of the primary pump until the min. flow threshold in the heat exchanger of the unit is exceeded.
 - this flow rate is indirectly monitored through the losses detected by the differential pressure transducer Δp_e
- In the required minimum load condition (that is, with all system terminals switched off) the necessary minimum volume (V_{min}) must be ensured by the relevant tank to be installed between the unit and the separator or the bypass pipe.

The temperature sensors of the system T provide a 4-20 mA signal and require 1/2" female fittings.

Further details can be found in the relevant manual.

FVPD FLOWZER VPS with TD-based control - automatic management of the variable flow rate, including control with constant temperature difference (TD) in the heat exchanger on the user side in systems featuring both the primary and secondary circuits.

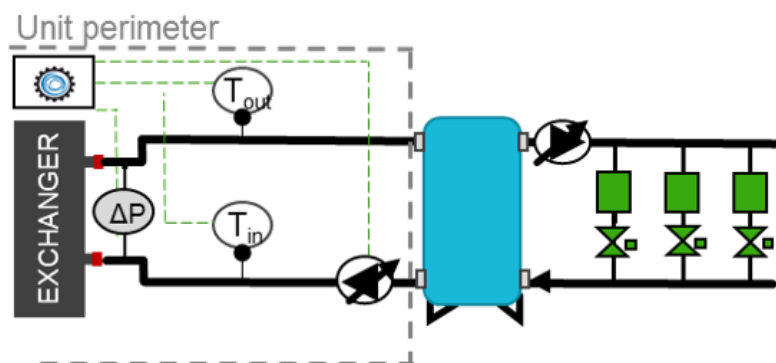

Bluethink solution for variable flow systems - ideal for systems featuring a primary and a secondary circuit physically divided by a heat exchanger or a tank with multiple connections.

flowzer vps with TD-based control includes:

- a differential pressure transducer, installed at the factory at the ends of the user-side heat exchanger of the unit (Δp_e)

The option must be necessarily combined with the Flowzer VP (inverter) and with one of the hydraulic modules that can be selected for the unit. The option is not compatible with the Multilogic version. Please refer to the HYZER solutions for the compatibility between variable flow systems and multi-machine systems.

The unit must include the advanced Bluethink controller and just one heat exchanger on the user side.

The option offers a complete default package to guarantee simple selection, purchasing and commissioning.

flowzer vps with TD-based control offers the following advantages:

- a full package that is easy to install as all the regulating devices are pre-assembled and pre-wired in the unit;
- achieving a complete variable flow system, with maximum energy saving
- the ideal solution to refurbish existing systems where the T different must be kept constant in the system, especially in comfort applications;

The maximum energy saving is achieved thanks to the advanced algorithm, which prevents hunting by the inverter and balances the pump speed and the recirculation flow rate to a minimum.

The dimensions of the inverter of the unit and of the pump module can be favoured by the low design discharge head of the primary circuit.

The operating principle can be summarized as follows:

- flowzer vps with TD-based control performs smart monitoring of the flow rate in the primary circuit, keeping the T difference constant in the heat exchanger;
- the system controller modulates the pump speed according to the condition detected by the temperature sensors (T) in the system, which are installed at the inlet and outlet of the heat exchanger on the user side;
- the difference in the water temperature (T) and flow rate are inversely proportional, which is why if the T difference is reduced at the same performance level, the water flow exceeds the flow required by the system and the pump speed is reduced in order to save energy;

on the other hand, when the load increases, the T difference increases in the system and the pump speed is increased accordingly.

- The check contributes to reducing/increasing the speed of the pump in the primary circuit until the min./max. flow threshold admitted in the heat exchanger of the unit is exceeded.
- this flow rate is indirectly monitored through the losses detected by the differential pressure transducer Δp_e

The temperature sensors of the system output a 4-20 mA signal.

Further details can be found in the relevant manual.

HFx HYZER E VFPP function

The HYZER E VFPP function combines the Multilogic function, which is designed to manage multi-machine systems, with the FLOWZER VFPP control for variable flow systems.

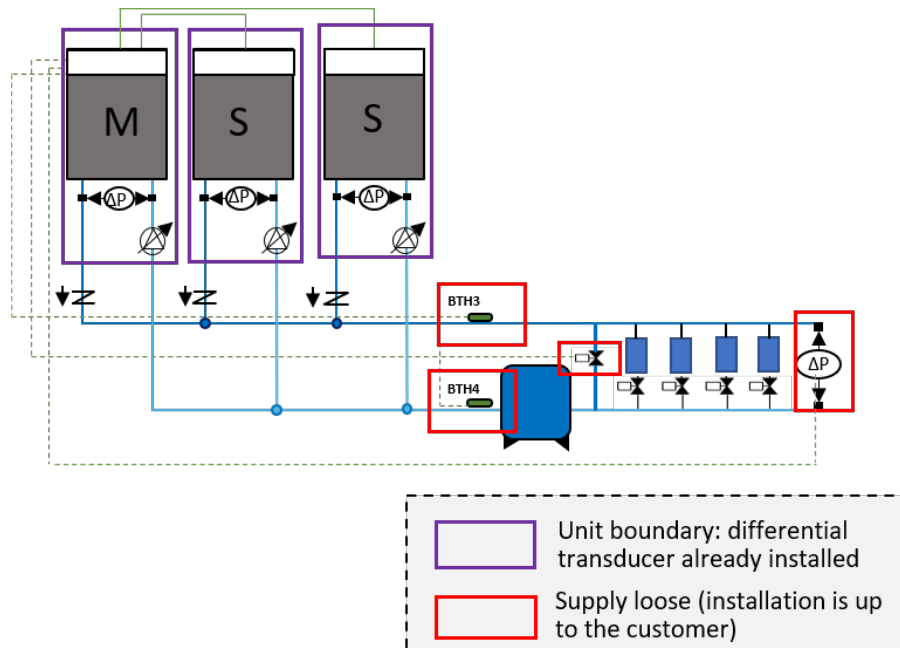

It is obligatory for the option to be combined with the Flowzer VP (inverter) and with one of the hydraulic modules that can be selected for the unit.

Units operate according to the Master/Slave logic that is typical of a Multilogic system. For additional details, please refer to the FMx option.

The HYZER E function requested with the unit can be:

- **HF0:** HYZER E VFPP function for Slave units;
- **HF2:** HYZER E VFPP function for the Master unit in order to manage up to 2 Slave units;
- **HF6:** HYZER E VFPP function for the Master unit in order to manage up to 6 Slave units.

If you need to connect more than 6 slaves (up to 31), you can ask for a quotation from our sales department.

For the slave units, the accessory includes:

- programming of the unit as slave of a system of machines in Multilogic network

For the master units, the accessory includes:

- programming of the unit as master of a system of machines in Multilogic network
- entering of the parameters necessary for connection with the individual slave units
- installation in the electrical control panel of a network switch to allow the units to be connected in a LAN network.
- the supply of 2 temperature probes to be positioned on the delivery and return manifold for system thermoregulation (supplied with the system - installation and wiring by the customer);
- the supply of two pressure transducers (supplied with the system - installation and wiring by the customer) to be installed near the system terminal that is affected by the highest head losses in the line or in any case in a position where it is possible to measure an adequate pressure value.
- The option also includes the supply of a bypass valve controlled by a 0-10 V signal, which must be selected in function of the system capacity. Please refer to the VBx options for correct selection.

The connection between the master unit and the slave units made with a CAT cable. 5E/UTP (prepared by the customer) with RJ45 connectors. Maximum cable length 100m.

For further details, please refer to the controller manual.

VBx VFPP bypass valve for HYZER E

The option is supplied with the bypass valve, which is selected according to the system capacity.

This option must be selected with either the "HYZER E VFPP function for Master unit to manage up to 2 Slave units" or "HYZER E VFPP function for Master unit to manage up to 6 Slave units".

	System capacity range**	Quantity	Diameter	Qmax**
	kW	-	in	m ³ /h
S_A	<240	1	2 1/2"	41.3
S_B	240÷335	1	3"	57.6
S_C	335÷570	1	4"	98
S_D	570÷850	1	5"	146.2
S_E	850÷1250	1	6"	215
S_F	1250÷1700	2	2 x 5"	2 x 146.2
S_G	1700÷2500	2	2 x 6"	2 x 215

** values based on a 5 °C temperature difference between the delivery and the return temperature

HSx HYZER E VPS function

The HYZER E VPS function combines the Multilogic function, which is used to manage multi-machine systems, with the FLOWZER VPS control for variable flow systems.

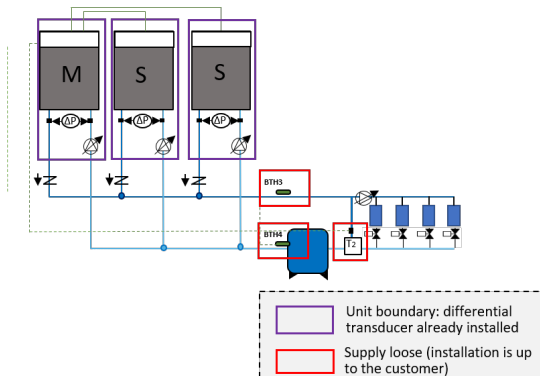

It is obligatory for the option to be combined with the Flowzer VP (inverter) and with one of the hydraulic modules that can be selected for the unit.

Units operate according to the Master/Slave logic that is typical of a Multilogic system. For additional details, please refer to the FMx option.

VPS control requires the installation on the machine of a differential transducer at the ends of the user-side heat exchanger in order to keep the flow rate in the system within a specific min. value allowed.

For additional details on the FLOWZER VPS logic, please refer to the dedicated FVPS option.

The networked units may be of different types, and the same observations as for the Multilogic option apply:

- if there are both chiller units and heat pumps in the network, the Master unit must obligatorily be one of the HP units;
- if there are both free-cooling and non free-cooling units in the network, the Master unit must obligatorily be one of the free-cooling units.

The HYZER E function requested with the unit can be:

- **HS0:** HYZER E VPS function for Slave units;
- **HS2:** HYZER E VPS function for the Master unit in order to manage up to 2 Slave units;
- **HS6:** HYZER E VPS function for the Master unit in order to manage up to 6 Slave units.

If you need to connect more than 6 slaves (up to 31), you can ask for a quotation from our sales department.

For the slave units, the accessory includes:

- programming of the unit as slave of a system of machines in Multilogic network

For the master units, the accessory includes:

- programming of the unit as master of a system of machines in Multilogic network
- entering of the parameters necessary for connection with the individual slave units
- installation in the electrical control panel of a network switch to allow the units to be connected in a LAN network.
- the supply of 2 temperature probes to be installed on the delivery manifold and on the bypass branch, which are typical of VPS control (supplied with the system - installation and wiring by the customer).

The connection between the master unit and the slave units made with a CAT cable. 5E/UTP (prepared by the customer) with RJ45 connectors. Maximum cable length 100m.

For further details, please refer to the controller manual.

HDx HYZER E VPS with DT-based control function

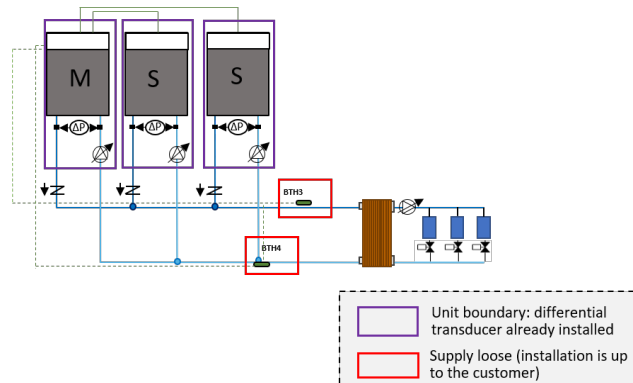

The HYZER E VPS with TD-based control function combines the Multilogic function, which is used to manage multi-machine systems, with the FLOWZER VPS with DT-based control control for variable flow systems.

It is obligatory for the option to be combined with the Flowzer VP (inverter) and with one of the hydraulic modules that can be selected for the unit.

Units operate according to the Master/Slave logic that is typical of a Multilogic system. For additional details, please refer to the FMx option.

VPS with DT-based control control requires the installation on the machine of a differential transducer at the ends of the user-side heat exchanger in order to keep the flow rate in the system within a specific min. value allowed.

For additional details on the FLOWZER VPS with TD-based control logic, please refer to the dedicated FVPS with DT-based control option.

The networked units may be of different types, and the same observations as for the Multilogic option apply:

- if there are both chiller units and heat pumps in the network, the Master unit must obligatorily be one of the HP units;
- if there are both free-cooling and non free-cooling units in the network, the Master unit must obligatorily be one of the free-cooling units.

The HYZER E function requested with the unit can be:

- **HD0:** HYZER E VPS with TD-based control function for Slave units;
- **HD2:** HYZER E VPS with TD-based control function for the Master unit in order to manage up to 2 Slave units;
- **HD6:** HYZER E VPS with TD-based control function for the Master unit in order to manage up to 6 Slave units.

If you need to connect more than 6 slaves (up to 31), you can ask for a quotation from our sales department.

For the slave units, the accessory includes:

- programming of the unit as slave of a system of machines in Multilogic network

For the master units, the accessory includes:

- programming of the unit as master of a system of machines in Multilogic network
- entering of the parameters necessary for connection with the individual slave units
- installation in the electrical control panel of a network switch to allow the units to be connected in a LAN network.

The connection between the master unit and the slave units made with a CAT cable. 5E/UTP (prepared by the customer) with RJ45 connectors. Maximum cable length 100m.

For further details, please refer to the controller manual.

PVX Variable flow setup for HYZER X

The dedicated HYZER X controller is designed to manage the different units, devices and components that make up a hydronic system.

Systems featuring this controller require that the PVX option be installed at the ends of the user-side heat exchanger of a differential pressure transducer so that the machine is set up for variable flow rate control.

This option is mandatory in all units making up the system.

For additional information on the product HYZER X, please refer to the specific technical catalogue.

VIX Shut-off valves for systems with external pumps for HYZER X

Systems featuring the HYZER X controller enable the selection of the shut-off valve used in systems that have an external pumping unit.

The option is always supplied separately from the unit and is for installation by the customer.

FLMX User-side flow meter for HYZER X

Systems featuring the HYZER X controller enable the selection of the flow meter option to calculate the flow rate and the performances of the units.

The option is supplied with the system for installation on the user side (installation by customer).

Electrical accessories

ARU Stopping of the unit due to temperatures below the operating limit

With this accessory, it is possible to set the unit so that the controller switches off the compressors when the unit is operating in heat pump mode and the external air temperature falls below a minimum set limit: this will prevent the unit from going into low pressure alarm, so avoiding having to manually restart the machine. When the external air temperature returns above the set threshold temperature, the unit will automatically resume operation without it being necessary to do anything.

For units equipped with integrated pump, the pump will always be kept running so as to prevent ice formation and ensure correct reading of the temperature and antifreeze safety probes at all times.

The stopping temperature must be set based on the set point temperature and in accordance with what is allowed by the operating limits of the machine.

CA Advanced control

With this accessory, the advanced control is used also for sizes/versions provided with the parametric control as standard.

COTW Outgoing water temperature control

With this accessory, outgoing instead of incoming water temperature control is used.

CSU Enabling for integration heater on user side

The accessory enables management of a heat source outside the unit which is supplementary to the user circuit.

CSS Enabling for integration heater on tap water side

The accessory enables management of a heat source outside the unit which is supplementary to the domestic hot water circuit.

CSP Set point compensation depending on external air temperature

For units fitted with this accessory, the set point of the unit is set so that it can vary between two values, a maximum and a minimum, depending on the external air temperature. The compensation ramp and the maximum and minimum values of the set point can be changed by the user.

Unless otherwise specified in the order, the controller will be set to implement a positive compensation logic according to the temperatures shown in the following diagrams:

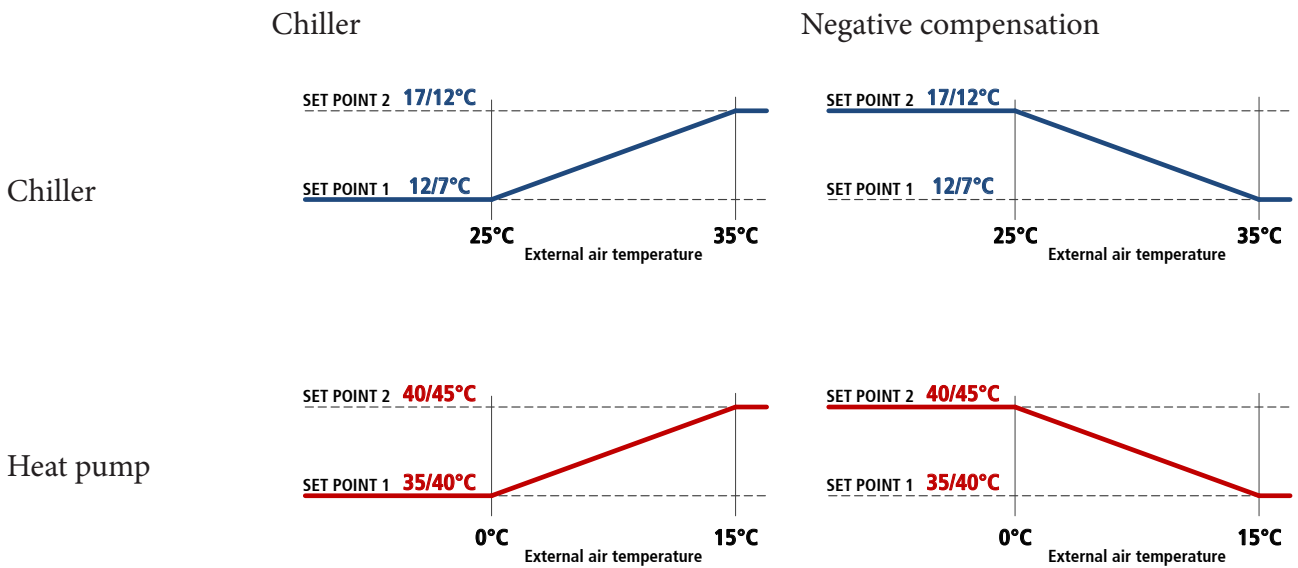

If the difference between the minimum set point and the maximum set point is greater than 5K, it is compulsory to ask for the accessory "Electronic expansion valve".

-
- CP Single potential free operating contacts**
For units fitted with this accessory, there are clean contacts available on the terminal board inside the electrical box from which the customer can acquire signals that show the status of the unit's components (compressors, fans, pumps, alarms).
- IACV Automatic circuit breakers**
With this accessory, automatic circuit breakers are installed instead of fuses for the protection of auxiliary loads. Also, the same accessory uses automatic circuit breakers with adjustable thermal overload protection to protect the compressors.
- LIID Limitation of the current absorbed by digital input**
When this accessory is requested, a digital input is prepared in the terminal board to activate the forced capacity reduction of the unit to a set fixed level.
This accessory is useful when there is a need to necessarily limit the power absorbed by the unit as regards particular conditions.
We point out that, in some conditions (for example, during defrosting, oil return cycles or hourly compressor rotation procedures), the controller could force the unit to operate at full capacity for limited periods of time.
- NSS Night Shift System**
This accessory is applied to high efficiency /LN version units with speed adjuster or to SLN units.
In the day time band, which is normally the one with the highest heat load, priority is given to efficiency and therefore the machine works with a fan control curve that maximises the EER. In this time band, therefore, the unit is a high efficiency low noise machine (equivalent to HE/LN). In the night time band (or in any case from time band decided by the customer), the priority changes to limiting the noisiness of the machine and therefore the controller carries out an adjustment of the control ramp of the condensing fans, thereby reducing the air flow rate and consequently the noise emission level. So, in this time band, the unit is a super low noise machine (equivalent to SLN). In any case, if there is a need for additional cooling capacity, the controller will manage the demand, if necessary, by accelerating the fans and keeping condensation within the correct operating limits. The time slots can be set from the control depending on installation requirements.
When the unit is working in heat pump mode, in order to maximise the COP and to obtain the widest possible operating limits, the control of the unit forces the fans to the maximum speed also during the night time bands.
- RE1P Relay for management of 1 external pump**
This accessory can be requested for units without pumps and allows a pump outside the machine to be controlled.
- RE2P Relay for management of 2 external pumps**
This accessory can be requested for units without pumps and allows two pumps outside the machine to be controlled with a running/stand-by logic by implementing a rotation on the hours of operation.
The two pumps are controlled by two separate relays.

RIF Power factor correction to $\cos\phi \geq 0.95$

With this accessory, an electrical control panel (IP54 protection rating), containing power factor correction capacitors to make the $\cos\phi$ of the unit greater than or equal to 0.95, is supplied with the unit. The capacitors should be connected (by the customer) to the electrical control panel of the unit in the specially prepared terminal board.

Besides reducing the absorbed reactive power, the use of this accessory also allows the maximum absorbed current to be lowered.

RMMT Maximum and minimum voltage relay

This accessory constantly monitors the voltage value and the unit's power supply phase sequence. If the supply voltage does not fall within the set parameters or there is a phase reversal, an alarm is generated that stops the machine to prevent damage to its main parts

SETD Double set point from digital input

The accessory allows you to preset two different operating set points and manage the change from one to the other through a digital signal.

The set point temperatures must be specified when ordering. For optimization of the unit, reference will be made to the lower set point in chiller mode and the higher set point in heat pump mode.

Unless otherwise specified in the order, the controller will be set at the factory with the following temperatures:

- in chiller mode, set point 1 to 7°C and set point 2 to 12°C
- in heat pump mode (only for HP units) set point 1 to 45°C and set point 2 to 40°C

For operating conditions other than standard, unless otherwise specified in the order for the second set point, the controller will be set at the factory:

- by adding 5°C to the main cooling set point
- by subtracting 5°C from the main heating set point

If necessary this value will however be limited to remain within the operating limits of the unit.

If the difference between set point 1 and set point 2 is greater than 5K, it is compulsory to ask for the accessory "Electronic expansion valve".

SETV Variable set point with remote signal

The accessory allows the set point to be varied continuously between two preset values, a maximum and a minimum, depending on an external signal that can be of the 0-1V, 0-10V or 4-20mA type.

The set point temperatures and the type of signal to use for the adjustment must be specified when ordering. For optimization of the unit, reference will be made to the lower set point in chiller mode and the higher set point in heat pump mode.

Unless otherwise specified in the order, the controller will be set at the factory with 0-10V analogue input and with the following temperatures:

- in chiller mode, 0V will correspond to a set point of 7°C and 10V will correspond to a set point of 12°C
- in heat pump mode (only for HP units), 0V will correspond to a set point of 45°C and 10V will correspond to a set point of 40°C

For operating conditions other than standard, unless otherwise specified in the order for the variable set point, the controller will be set at the factory:

- by adding 5°C (10V) to the main cooling set point (0V)
- by subtracting 5°C (10V) from the main heating set point (0V)

If necessary this value will however be limited to remain within the operating limits of the unit.

If the difference between the minimum set point and the maximum set point is greater than 5K, it is compulsory to ask for the accessory "Electronic expansion valve".

SOFT Electronic soft-starter

The scroll compressors have DOL (Direct On Line) starting and therefore the maximum inrush current I_{MIC} will be 4/5 times its nominal current I_{nom} .

If the unit is equipped with the electronic soft-starter accessory, the starting of each compressor is done with an acceleration ramp that allows the effective value (rms value) of the inrush current of the individual compressor to be lowered.

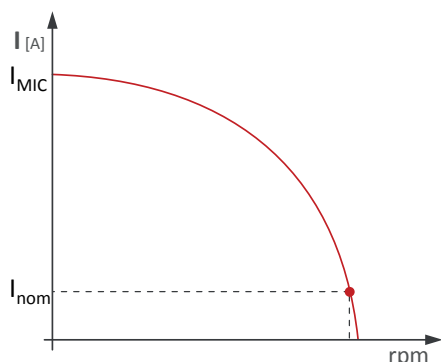

Current trend without accessory Electronic soft-starter

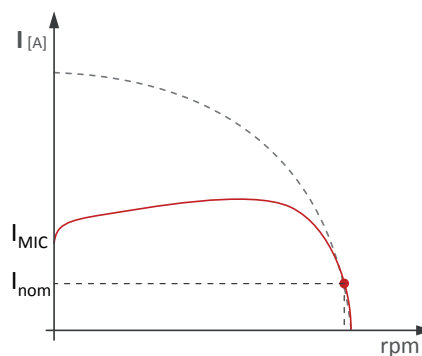

Current trend with accessory Electronic soft-starter

If the unit is equipped with accessory "Power factor correction to $\cos\phi \geq 0.95$ ", this last will be electro-mechanically connected only at the end of the acceleration ramp of the soft-starter.

SQE Heater for electrical control panel

Electric heaters are positioned inside the electrical control panel and these prevent the formation of ice or condensation inside it.

TERM Remote-controlled user terminal panel

This accessory allows the terminal normally situated on the machine to be replicated on a support situated at a distance. It is particularly suitable when the unit is placed in an area that is not easily accessible.

The accessory is supplied loose and is to be installed by the customer at a maximum distance of 120m from the unit. We advise using a cable of the following type: "TECO O.R. FE 2x2xAWG24 SN/ST/PUR".

For this accessory, there is a dedicated serial port.

ENM Energy meter

The accessory allows the main electrical quantities (including voltage, current, power) to be read on the three phases, via current transformer.

This accessory communicates with the BlueThink controller to supervise the monitored data. The values measured are then made available through the unit display and the web server.

ENML Energy meter with current limiter

The accessory allows the main electrical quantities (including voltage, current, power) to be read on the three phases, via current transformer.

This accessory communicates with the BlueThink controller to supervise the monitored data. The values measured are then made available through the unit display and the web server.

This accessory is designed to limit the maximum current the unit can absorb. The controller instantly checks the absorption levels and, where necessary, it applies a forced capacity reduction that keeps the absorbed current value below the stored threshold.

AS Automatic management of domestic hot water

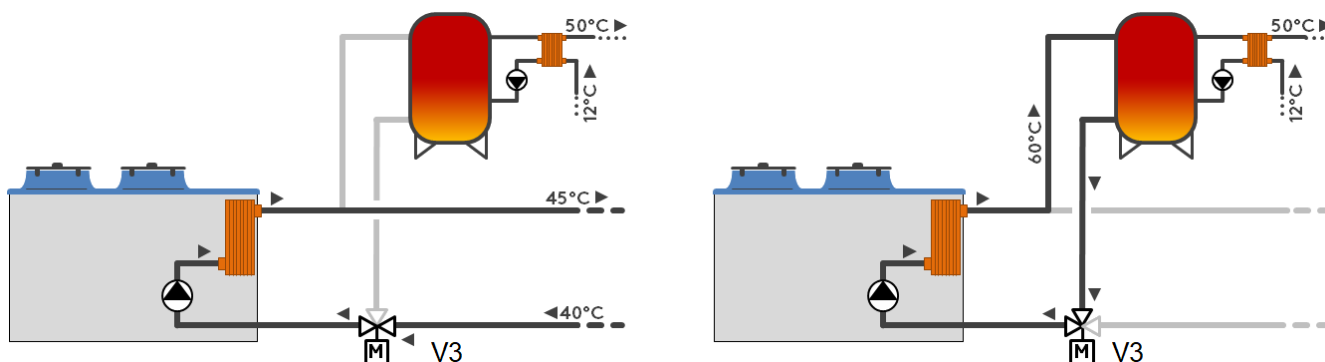

This function enables the unit to control the temperature inside a domestic hot water storage tank and to manage a 3-way valve outside the unit (available as an accessory).

The water temperature in the domestic hot water tank is controlled through a dedicated probe situated in the tank.

Normally, the heat pump operates on the system to meet the comfort requirements of the building, but when the water temperature in the domestic hot water tank falls below a set threshold, the controller switches to domestic hot water production.

If the unit is operating as heat pump for heating, the 3-way valve will be switched and the set point changed. On the other hand, if the unit is producing chilled water for air conditioning, the controller switches the unit to heat pump mode, gives it the set point for domestic hot water and turns the 3-way valve to the appropriate position. Once the temperature in the domestic hot water tank has reached the set value, the unit automatically returns to producing water for the heating or air conditioning system.

When there is a defrost request, the 3-way valve is always forced to position itself on the system, whatever operating mode it may be in.

Domestic hot water production is always given priority.

With this accessory there are two digital inputs in the electrical control panel for respectively deactivating domestic hot water production and the production of water for the heating/air conditioning system.

When the unit is working in "domestic hot water only" mode, the pump is normally off and is switched on only for the time required to meet the demand for domestic hot water production.

When this accessory is fitted, the machine must have control of pump operation. This means that either the unit is equipped with one of the hydronic modules available in the catalogue (therefore with at least one pump installed on it) or the relay for external pump management must be requested as accessory.

The probe to be fitted in the domestic hot water tank is supplied with the unit with a 5m long cable. The probe is used to measure the water temperature in the hottest part of the tank, so it must be positioned in a specially prepared pocket and secured using heat conducting paste. Installation by the customer.

In case of management with variable water flow, the installation must necessarily be made with the derivation towards the domestic hot water tank upstream of any bypass valve or channel.

ENT Energy trend

This function estimates the energy consumption and the cooling and heating production of the unit. The efficiency of the unit is calculated ("EER" for cooling operation or "COP" for heating operation).

Data are calculated in real time according to the working conditions of the unit (evaporation and condensing pressure, external air temperature).

Data are also displayed in the unit user interface in a dedicated "Energy Trend" mask.

Following data are also recorded in the logs in the controllers memory:

- "EnergyTrendHours" contains records of the values of energy absorbed and produced for each hour
- "EnergyTrendHistory" contains records of the values of energy absorbed and produced for each day

The "logs" can then be downloaded via a USB pendrive or from the WEB pages.

The function returns values within the operating envelope of the machine. No data will be recorded outside the operating envelope. The data is stored as an hourly average for 12 months of operation. After 12 months the control overwrites the first data. If hourly resolution is required, the data must be downloaded at least once a year. The control also stores daily average data. This is stored for the life of the unit. In case of microprocessor board failure, data, if not previously downloaded and saved, will be lost.

Network accessories

BEET Blueye® via Ethernet

Blueye® is a supervision platform that enables remote monitoring of one or more units in the same system interconnected through a network with Modbus protocol.

This accessory features the Blueeye device, as already installed and wired in the unit.

The critical variables to be monitored over time are identified for each connected device. These variables are sampled and saved to the cloud so that they are accessible at all times through a web portal or a mobile APP (available for Android and iOS).

The following options can be selected for connection to the internet:

- a LAN (Ethernet) connection - available in the system;
- a connection to a mobile network - at least 3G. The data SIM card is not included.

Three different types of contracts can be signed.

Blueye® Cloud Basic:

- to monitor a max. of 20 variables in total over max. 5 units/peripherals;
- to set a min. sampling frequency of 60 seconds.

Blueye® Cloud Advanced:

- to monitor a max. of 200 variables in total over max. 10 units/peripherals;
- to set a min. sampling frequency of 5 seconds.

Blueye® Connect:

- To monitor up to 10 units/peripherals.

Subscribing to any of the **Blueye® Cloud** enables:

- viewing the history of the monitored variables, in the form of both numerical values and graphs;
- downloading the history of variables in CSV format;
- the creation of automatic reports;
- setting notifications (via APP or mail) with settable thresholds for each variable;
- switching the unit ON/OFF remotely;;
- changing the set point remotely;
- selection of SUMMER/WINTER mode remotely (for reversible units only).

The subscription to the **Blueye® Connect** service offers the advantages below:

- a safe connection (tunnelling) between the user and the remote unit through the Blueye® portal;
- full access to the remote controller;
- real time monitoring;
- software upgrading.

Blueye® via Ethernet is only available for units supplied with an advanced controller and does not include any type of service. This service must be purchased separately based on the number of units/devices to be connected and the number of variables to be monitored. In order to connect multiple units to **Blueye® device, the network switch is required (this accessory is sold separately).**

Units can also be connected to the Blueeye device through the RS485 network featuring a Modbus RTU protocol (for this option, refer to BERS accessory).

For further details, refer to the specific Blueeye® documentation.

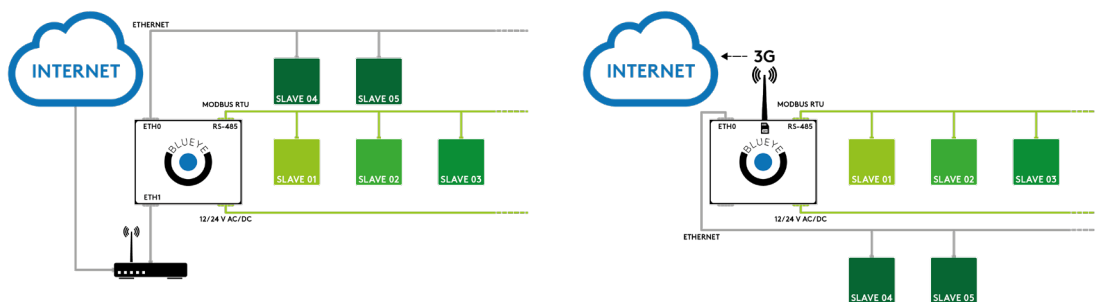

BERS Blueye® via RS485

This accessory requires use of the Blueye device, installed and wired in the unit through a RS485 serial port on the ModBus RTU protocol.

This option requires integration with one contract of the Blueye Cloud series. (Basic or Advanced one)

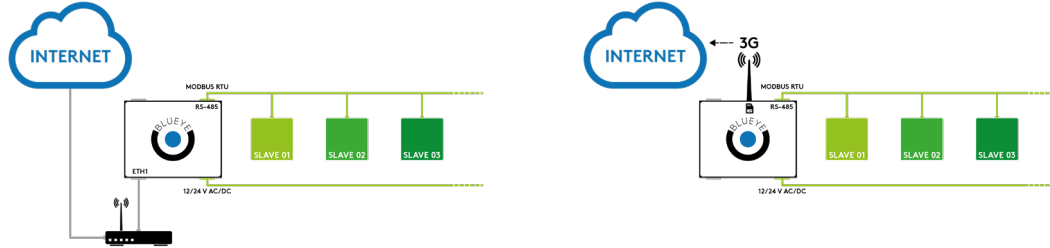

FMx Multilogic Function

The Multilogic function allows management of up to 32 units equipped with advanced Bluethink controller and connected in hydraulic parallel with each other.

Multilogic systems only operate with the "Ipro" advanced controller and if the connected units have the same software version. A Multilogic network cannot operate with different software versions/releases.

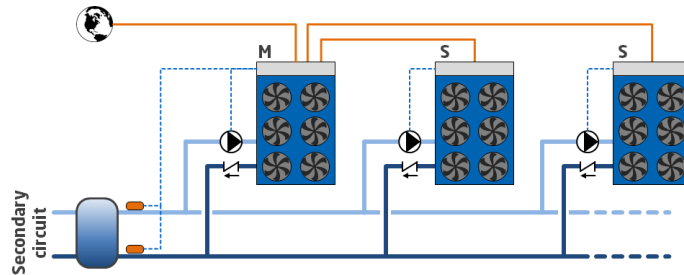

On the basis of the information recorded by the temperature probes installed on the delivery and return manifolds of the system, with the master unit, a capacity request is generated that is distributed among the units connected in the Multilogic network according to settable priority and optimization logics.

The connected units can be different from each other, in terms of capacity and set-up, provided the following rules are complied with:

If communication between the units fails or if the master is off-line, the slave units can continue to work according to the set thermoregulation parameters.

The connected units can be different from each other, in terms of capacity and set-up, provided the following rules are complied with:

- if there are both chiller units and heat pumps in the Multilogic network, the Master unit must obligatorily be one of the HP units
- if there are both free cooling and non free-cooling units in the Multilogic network, the Master unit must obligatorily be one of the free-cooling units.

The Multilogic function that can be requested with the unit can be:

- **FM0:** Multilogic function for Slave unit
- **FM2:** Multilogic function for Master unit for managing up to 2 Slaves
- **FM6:** Multilogic function for Master unit for managing up to 6 Slaves

If you need to connect more than 6 slaves (up to 31), you can ask for a quotation from our sales department.

For the slave units, the accessory includes:

- programming of the unit as slave of a system of machines in Multilogic network

For the master units, the accessory includes:

- programming of the unit as master of a system of machines in Multilogic network
- entering of the parameters necessary for connection with the individual slave units
- installation in the electrical control panel of a network switch to allow the units to be connected in a LAN network.
- the supply of 2 temperature probes to be positioned on the delivery and return manifold of the system (supplied separately with it, installation and wiring by the customer)

The connection between the master unit and the slave units made with a CAT cable. 5E/UTP (prepared by the customer) with RJ45 connectors. Maximum cable length 100m.

For further details, please refer to the controller manual.

SW4P Network switch with 4 ports

The accessory includes installation in DIN rail of a professional 4-port network switch. Requires Blueeye via Ethernet.

SW8P Network switch with 8 ports

The accessory includes installation in DIN rail of a professional 8-port network switch. Requires Blueeye via Ethernet.

PSN SNMP protocol

The accessory consists of a gateway that allows Ethernet connection to a SNMP manager supervision system. The use of this accessory causes the RS485 serial port to be unavailable.

GLO Modbus Lonworks Gateway

With this accessory, a RS485/Lon gateway is installed inside the electrical control panel. By default, the programming gives read-only access to the control of the unit. Reading / writing access is available on field with a service level.

PBA BACnet protocol over IP (Ethernet)

The controller is set for use, in read and write mode, of the BACnet port on IP protocol. By default, the programming gives read-only access to the control of the unit. Reading / writing access is available on field with a service level.

SERI RS485 serial connection with Modbus protocol

RS485 serial connection with Modbus protocol

SMAR Smartlink function predisposition

This accessory makes it possible to connect the controller of the unit with the controller of a Swegon GOLD™ air handling unit via a simple serial cable, so allowing their operating logics to be merged into a single consciousness that pursues the maximum energy efficiency of the system. The RS485 serial interface is already included and dedicated to connection with Swegon units.

The option is incompatible with:

- double set point
- variable set point with remote signal
- summer/winter selection by digital input
- set point compensation depending on external air temperature
- multilogic
- all communication protocols.

SMAP Setup of Smartlink+ functions

This option is used to connect the controller in the unit with the controller of a Swegon GOLD™ air handling unit via the Ethernet port TCP/IP, so allowing the operating logics of hydronic and ventilation systems to be merged into a single logic for the achievement of maximum energy efficiency and comfort. This option is only available for units featuring an advanced controller and it is compatible with Multilogic and Hyzer systems only if the machine is the Master.

The option is incompatible with:

- double set point
- variable set point with remote signal
- set point compensation depending on external air temperature
- all communication protocols.

Other accessories

AG Rubber anti-vibration mounts

These allow you to reduce the vibrations transmitted from the unit to the surface it is standing on. Accessory supplied loose.

ALPR Pre-painted aluminium coil

This option uses finned pack coils with copper tubes and pre-painted aluminium fins.

ANTC Coil treated with anti-corrosion paints

The treatment is applied to the finned pack coils with copper pipes and aluminum fins and consists in the passivation of the aluminum with a polyurethane base through a procedure of immersion and then of a spray application of the coating that guarantees a double protection of the finning all over the exposure to the most aggressive environmental conditions even for more particular (or niche) process applications.

Specifically, the immersion process guarantees complete coverage of galvanic corrosion while the application of the spray protects the ends of the fins which represent the critical point for the initiation of the corrosion phenomenon.

The choice of whether or not to treat the exchanger should be made in relation to the environment in which the unit is to be installed and through observation of other structures and machinery with exposed metal surfaces present in the destination environment.

The cross observation criterion is the most valid method of selection currently available without having to carry out preliminary tests or measurements with instruments.

Protective treatment of the exchanger is strongly recommended if at least one of the points below is verified:

- there are obvious signs of corrosion on the exposed metal surfaces in the installation area
- the installation is located close to the sea coast
- the prevailing winds come from the sea and travel in the direction of the unit
- the environment is industrial with a significant concentration of pollutants
- it is an urban environment with a high population density
- it is a rural environment with the presence of organic discharges and effluents

For chiller units, this accessory also includes the "Cu/Al coil" accessory.

With reference to the protection criteria to follow, especially for installations close to the coast, refer to the section titled "Installations that require the use of treated coils".

IDRO Coil pack with hydrophilic coating

Hydrophilic coating is a special treatment applied to the finned coils (source side) in heat pump units to facilitate drainage of the condensate that forms on the surface of the heat exchanger.

This treatment causes the water vapour to form a film of condensate on the surfaces of the fins, which, thanks to the low surface tension, drains rapidly into the drip tray (if present) positioned beneath the coils.

Compared to traditional finned coils in untreated aluminium, the hydrophilic coating delays the necessity to defrost the heat exchanger, thereby extending the interval between defrosting cycles and boosting its efficiency and, hence, improving the performance and energy consumption of the heat pump.

In the absence of the hydrophilic coating, the humidity present in the air condenses in the form of drops, which, due to the greater friction, are more likely to remain trapped within the coil pack, limiting the passage of air and impacting negatively on heat exchange, this causes the surface temperature to drop further (due to a decrease in the evaporation temperature), facilitating the formation of ice and reducing the interval between defrosting cycles. This effect is even more pronounced in the case of installations in particularly windy areas.

The following is a comparison between a standard finned coil pack and a pack treated with the hydrophilic coating at the end of the defrosting cycle, on the same unit, with an external DB air temperature of -2°C. Note the residual presence of water droplets on the untreated heat exchanger, as compared to perfectly clean surface of the treated unit.

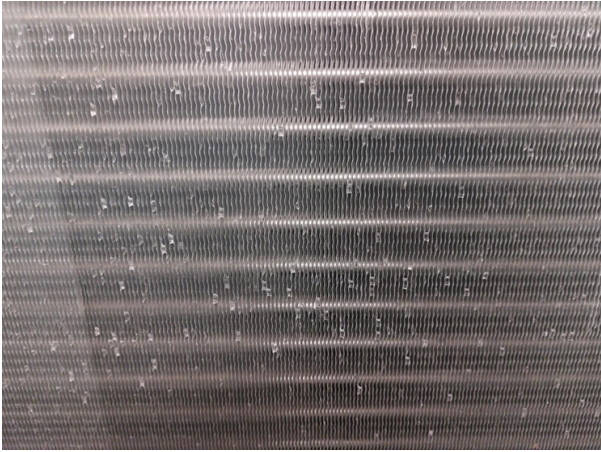

Standard, untreated coil pack

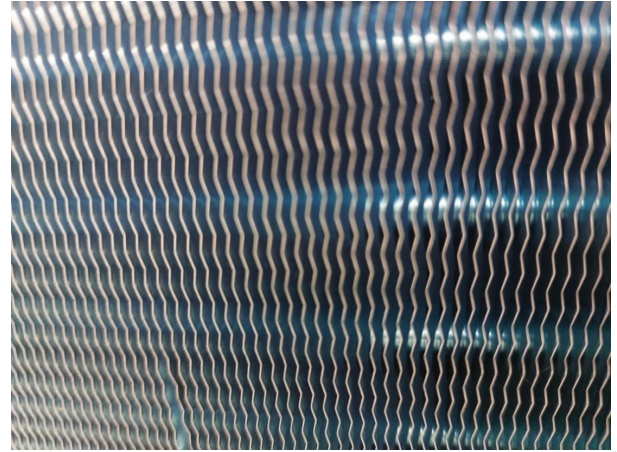

Coil pack with hydrophilic coating

While it is not specifically designed for use in marine environments, an additional advantage of the hydrophilic coating is its greater resistance to salt fog conditions with respect to untreated aluminium.

To avoid compromising the benefits of applying the treatment, or prevent additional problems from arising in the case of untreated units, it is also necessary to ensure the condensed water is drained correctly, so as to prevent the formation of ice at the base of the heat exchanger, which could cause it to extend to the entire coil pack, compromising the efficiency of the defrosting cycle, and hence the operation and performance of the unit.

With this in mind, the following accessories are available:

- VASC_condensate drip tray (available either as standard or optional, depending on the series/model of the unit)
- RAV_anti-freeze element (available either as standard or optional, depending on the series/model of the unit)
- RAM_high power anti-freeze element
- KTC_drip tray connector tube kit (for units equipped with drip tray)

The hydrophilic coating is not compatible with other treatments included in the price list.

SLIT Special pallet/skid for container shipment

The unit is placed on a skid that makes the container loading and unloading operations easier.

The accessory is mandatory if shipping by container is required

MCHE E-coated microchannel coil

The e-coated microchannel coils are treated by immersion of the whole exchanger in an emulsion of organic resins, solvents, ionic stabilisers and deionised water. This is all subjected to a suitable electric field that causes the formation of a solid, uniform deposit on the exchanger. The function of this deposit will be to protect the aluminium from corrosion without penalising its thermophysical properties.

Protective treatment of the exchanger is strongly recommended if at least one of the points below is verified:

- there are obvious signs of corrosion of the exposed metal surfaces in the installation area
- the installation is located close to the sea coast
- the prevailing winds come from the sea towards the unit
- the environment is industrial with a significant concentration of pollutants
- the environment is urban with a high population density
- the environment is rural with the presence of organic discharges and effluents.

With reference to the protection criteria to follow, especially for installations close to the coast, refer to the section titled "Installations that require the use of treated coils".

RAAL Cu/Al coils

This accessory uses finned pack coils with copper tubes and aluminium fins instead of microchannel coils.

RAV Anti-freeze heater for condensate drip tray

A heating cable, glued to the bottom, can be combined with the condensate drip tray to prevent ice formation at the base of the coil or near the drains.

The heater is controlled by a thermostat and is activated depending on the external air temperature.

Recommended accessory for installations in cold regions.

RETE Coil protection mesh with metal filter

Coil protection mesh with hail-proof metal filter

VASC Condensate drip tray

This accessory can be combined with HP units in order to collect the condensate that forms after each coil defrost cycle. The tray is made of steel and is placed under the source-side heat exchanger, at a suitable distance.

On the opposite sides of the tray, there are some 1" close nipples to allow the customer to connect a pipe to it for draining out the water so as not to cause harm or damage to people or objects.

TECHNICAL SPECIFICATIONS

ZETA SKY R7 [R32]

			3.2	4.2	5.2	6.2	7.2	8.2
Cooling								
Refrigeration capacity	(1)	kW	45.29	50.49	54.69	61.89	75.49	80.99
Total absorbed power	(1)	kW	13.39	15.49	16.99	19.39	23.19	25.49
EER	(1)		3.383	3.26	3.219	3.192	3.256	3.178
Eurovent efficiency class	(1)		A	A	A	A	A	A
Compressors								
Compressors/Circuits		n°	2/1	2/1	2/1	2/1	2/1	2/1
Minimum capacity reduction step	(7)	%	50	50	50	50	50	50
Refrigerant charge CH (MCHX)	(3)	kg	4.1	4.6	4.6	7	8	8
Refrigerant charge CH (Cu/Al)	(3)	kg	7	7.2	7.7	9.2	11.9	12.8
Fans								
Quantity		n°	2	2	2	2	3	3
Total air flow rate CH (MCHX)		m³/h	18000	18000	18000	19000	28000	28000
User-side heat exchanger								
Quantity		n°	1	1	1	1	1	1
Water flow rate CH	(1)	m³/h	7.8	8.7	9.4	10.7	13	14
Pressure drop CH	(1)	kPa	21	26	20	25	21	24
Noise levels								
Sound power level cooling	(4)	dB(A)	78	79	79	80	81	82
Sound pressure level cooling	(6)	dB(A)	46	48	48	48	49	50
Sound power level of vers. LN cooling	(4)	dB(A)	76	77	77	78	79	80
Sound pressure level of vers. LN cooling	(6)	dB(A)	44	46	46	46	47	48
Dimensions and weights**								
Length		mm	2258	2258	2258	3258	3258	3258
Depth		mm	1030	1030	1030	1134	1134	1134
Height		mm	1799	1799	1799	1799	1799	1799
Operating weight		kg	535	570	572	801	851	854

CH: chiller unit; HP: heat pump unit; MCHX: unit with microchannel coils

- (1) External air temperature of 35°C and user-side heat exchanger water inlet-outlet temperature of 12-7°C. Values compliant with standard EN 14511
- (2) Outside air temperature 7°C DB, 6°C WB; condenser inlet/outlet water temperature 40/45°C. Values compliant with standard EN 14511
- (3) Theoretical values referred to the basic unit. The amount of gas actually charged in the unit may differ.
- (4) Unit operating at rated capacity, with no accessories of any kind - external air temperature 35°C and water input/output temperature from/to heat exchanger and user equal to 12/7°C. Values taken by measurements made in accordance with standard ISO 3744 and the Eurovent certification programme, where applicable. Binding values See NOISE LEVELS section.
- (5) unit operating at nominal operating capacity, with no accessories of any kind, with external air temperature of 7°C (6°C WB) and user-side heat exchanger water inlet/outlet temperature of 40/45°C. Values obtained from measurements carried out in accordance with standard ISO 3744.
- (6) Values obtained from the sound power level (conditions: note 4), related to a distance of 10 m from the unit in free field with directivity factor Q=2. Non-binding values See NOISE LEVELS section.
- (7) Approximate value. The minimum capacity reached by the unit depends on the operating conditions. The value shown may not be suitable for calculating the minimum volume of water: to do this, consult the "Minimum water content in the system" section.
- (8) Former Eurovent's seasonal efficiency index. Value not certified by Eurovent from 2019. Reference: base unit, without any accessories

** Basic unit without included accessories

The certified standard performances and data can be verified in <https://www.eurovent-certification.com>

Some voluntary data are not certified (i.e. Noise Level for water source units; SCOP for units with Pdesign >70 KW; SCOP MT values).

ZETA SKY R7 [R32]

			9.2	10.2	12.2	13.2	15.2	17.2
Cooling								
Refrigeration capacity	(1)	kW	101.09	112.19	124.09	141.89	160.49	185.29
Total absorbed power	(1)	kW	29.69	33.59	38.29	41.24	48.04	55.84
EER	(1)		3.405	3.34	3.241	3.441	3.341	3.319
Eurovent efficiency class	(1)		A	A	A	A	A	A
Compressors								
Compressors/Circuits		n°	2/1	2/1	2/1	2/1	2/1	2/1
Minimum capacity reduction step	(7)	%	50	50	50	50	50	50
Refrigerant charge CH (MCHX)	(3)	kg	10	10	10	13.7	14.5	14.7
Refrigerant charge CH (Cu/Al)	(3)	kg	14.6	15	18	22	22	21.5
Fans								
Quantity		n°	2	2	2	3	3	3
Total air flow rate CH (MCHX)		m³/h	42000	42000	42000	63000	63000	63000
User-side heat exchanger								
Quantity		n°	1	1	1	1	1	1
Water flow rate CH	(1)	m³/h	17.4	19.3	21.4	24.5	27.7	31.9
Pressure drop CH	(1)	kPa	38	31	31	40	35	47
Noise levels								
Sound power level cooling	(4)	dB(A)	83	84	86	87	87	87
Sound pressure level cooling	(6)	dB(A)	51	52	54	55	55	55
Sound power level of vers. LN cooling	(4)	dB(A)	81	82	84	85	85	85
Sound pressure level of vers. LN cooling	(6)	dB(A)	49	50	52	53	53	53
Dimensions and weights**								
Length		mm	3258	3258	3258	4259	4259	4259
Depth		mm	1126	1126	1126	1126	1126	1126
Height		mm	2380	2380	2380	2376	2376	2376
Operating weight		kg	1067	1098	1146	1366	1432	1458

CH: chiller unit; HP: heat pump unit; MCHX: unit with microchannel coils

- (1) External air temperature of 35°C and user-side heat exchanger water inlet-outlet temperature of 12-7°C. Values compliant with standard EN 14511
(2) Outside air temperature 7°C DB, 6°C WB; condenser inlet/outlet water temperature 40/45°C. Values compliant with standard EN 14511
(3) Theoretical values referred to the basic unit. The amount of gas actually charged in the unit may differ.
(4) Unit operating at rated capacity, with no accessories of any kind - external air temperature 35°C and water input/output temperature from/to heat exchanger and user equal to 12/7°C. Values taken by measurements made in accordance with standard ISO 3744 and the Eurovent certification programme, where applicable. Binding values See NOISE LEVELS section.
(5) unit operating at nominal operating capacity, with no accessories of any kind, with external air temperature of 7°C (6°C WB) and user-side heat exchanger water inlet/outlet temperature of 40/45°C. Values obtained from measurements carried out in accordance with standard ISO 3744.
(6) Values obtained from the sound power level (conditions: note 4), related to a distance of 10 m from the unit in free field with directivity factor Q=2. Non-binding values See NOISE LEVELS section.
(7) Approximate value. The minimum capacity reached by the unit depends on the operating conditions. The value shown may not be suitable for calculating the minimum volume of water: to do this, consult the "Minimum water content in the system" section.
(8) Former Eurovent's seasonal efficiency index. Value not certified by Eurovent from 2019. Reference: base unit, without any accessories

** Basic unit without included accessories

The certified standard performances and data can be verified in <https://www.eurovent-certification.com>

Some voluntary data are not certified (i.e. Noise Level for water source units; SCOP for units with Pdesign >70 KW; SCOP MT values).

ZETA SKY R7 [R32]

			14.4	16.4	18.4	20.4	24.4
Cooling							
Refrigeration capacity	(1)	kW	145.19	173.39	189.39	203.89	237.79
Total absorbed power	(1)	kW	43.24	54.74	59.54	66.44	81.64
EER	(1)		3.358	3.168	3.181	3.069	2.913
Eurovent efficiency class	(1)		A	A	A	B	C
Compressors							
Compressors/Circuits		n°	4/2	4/2	4/2	4/2	4/2
Minimum capacity reduction step	(7)	%	25	25	25	25	25
Refrigerant charge CH (MCHX)	(3)	kg	16.2	16	16.8	16.5	16.8
Refrigerant charge CH (Cu/Al)	(3)	kg	25.4	22.7	24.8	23	23.5
Fans							
Quantity		n°	3	3	3	3	3
Total air flow rate CH (MCHX)		m³/h	63000	63000	63000	63000	63000
User-side heat exchanger							
Quantity		n°	1	1	1	1	1
Water flow rate CH	(1)	m³/h	25	29.9	32.6	35.1	41
Pressure drop CH	(1)	kPa	16	22	22	25	24
Noise levels							
Sound power level cooling	(4)	dB(A)	84	85	87	89	90
Sound pressure level cooling	(6)	dB(A)	52	53	55	57	58
Sound power level of vers. LN cooling	(4)	dB(A)	82	83	85	87	88
Sound pressure level of vers. LN cooling	(6)	dB(A)	50	51	53	55	56
Dimensions and weights**							
Length		mm	4259	4259	4259	4259	4259
Depth		mm	1126	1126	1126	1126	1126
Height		mm	2376	2376	2376	2376	2376
Operating weight		kg	1478	1478	1658	1708	1808

CH: chiller unit; HP: heat pump unit; MCHX: unit with microchannel coils

- (1) External air temperature of 35°C and user-side heat exchanger water inlet-outlet temperature of 12-7°C. Values compliant with standard EN 14511
(2) Outside air temperature 7°C DB, 6°C WB; condenser inlet/outlet water temperature 40/45°C. Values compliant with standard EN 14511
(3) Theoretical values referred to the basic unit. The amount of gas actually charged in the unit may differ.
(4) Unit operating at rated capacity, with no accessories of any kind - external air temperature 35°C and water input/output temperature from/to heat exchanger and user equal to 12/7°C. Values taken by measurements made in accordance with standard ISO 3744 and the Eurovent certification programme, where applicable. Binding values See NOISE LEVELS section.
(5) unit operating at nominal operating capacity, with no accessories of any kind, with external air temperature of 7°C (6°C WB) and user-side heat exchanger water inlet/outlet temperature of 40/45°C. Values obtained from measurements carried out in accordance with standard ISO 3744.
(6) Values obtained from the sound power level (conditions: note 4), related to a distance of 10 m from the unit in free field with directivity factor Q=2. Non-binding values See NOISE LEVELS section.
(7) Approximate value. The minimum capacity reached by the unit depends on the operating conditions. The value shown may not be suitable for calculating the minimum volume of water: to do this, consult the "Minimum water content in the system" section.
(8) Former Eurovent's seasonal efficiency index. Value not certified by Eurovent from 2019. Reference: base unit, without any accessories

** Basic unit without included accessories

The certified standard performances and data can be verified in <https://www.eurovent-certification.com>

Some voluntary data are not certified (i.e. Noise Level for water source units; SCOP for units with Pdesign >70 KW; SCOP MT values).

ZETA SKY R7 SLN [R32]

			3.2	4.2	5.2	6.2	7.2	8.2
Cooling								
Refrigeration capacity	(1)	kW	43.99	48.69	52.59	59.29	73.09	77.99
Total absorbed power	(1)	kW	13.61	15.91	17.61	20.31	23.82	26.42
EER	(1)		3.23	3.06	2.98	2.92	3.06	2.95
Eurovent efficiency class	(1)		A	B	B	C	B	B
Compressors								
Compressors/Circuits		n°	2/1	2/1	2/1	2/1	2/1	2/1
Minimum capacity reduction step	(7)	%	50	50	50	50	50	50
Refrigerant charge CH (MCHX)	(3)	kg	4.1	4.6	4.6	7	8	8
Refrigerant charge CH (Cu/Al)	(3)	kg	7	7.2	7.7	9.2	11.9	12.8
Fans								
Quantity		n°	2	2	2	2	3	3
Total air flow rate CH (MCHX)		m³/h	13400	13800	13800	14500	21600	21200
User-side heat exchanger								
Quantity		n°	1	1	1	1	1	1
Water flow rate CH	(1)	m³/h	7.6	8.4	9.1	10.2	12.6	13.4
Pressure drop CH	(1)	kPa	20	24	18	23	20	23
Noise levels								
Sound power lev. SLN vers.	(4)	dB(A)	74	75	75	76	77	78
Sound pressure lev. SLN vers.	(6)	dB(A)	42	44	44	44	45	46
Dimensions and weights**								
Length		mm	2258	2258	2258	3258	3258	3258
Depth		mm	1030	1030	1030	1134	1134	1134
Height		mm	1799	1799	1799	1799	1799	1799
Operating weight		kg	535	570	572	801	851	854

CH: chiller unit; HP: heat pump unit; MCHX: unit with microchannel coils

- (1) External air temperature of 35°C and user-side heat exchanger water inlet-outlet temperature of 12-7°C. Values compliant with standard EN 14511
- (2) Outside air temperature 7°C DB, 6°C WB; condenser inlet/outlet water temperature 40/45°C. Values compliant with standard EN 14511
- (3) Theoretical values referred to the basic unit. The amount of gas actually charged in the unit may differ.
- (4) Unit operating at rated capacity, with no accessories of any kind - external air temperature 35°C and water input/output temperature from/to heat exchanger and user equal to 12/7°C. Values taken by measurements made in accordance with standard ISO 3744 and the Eurovent certification programme, where applicable. Binding values See NOISE LEVELS section.
- (5) unit operating at nominal operating capacity, with no accessories of any kind, with external air temperature of 7°C (6°C WB) and user-side heat exchanger water inlet/outlet temperature of 40/45°C. Values obtained from measurements carried out in accordance with standard ISO 3744.
- (6) Values obtained from the sound power level (conditions: note 4), related to a distance of 10 m from the unit in free field with directivity factor Q=2. Non-binding values See NOISE LEVELS section.
- (7) Approximate value. The minimum capacity reached by the unit depends on the operating conditions. The value shown may not be suitable for calculating the minimum volume of water: to do this, consult the "Minimum water content in the system" section.
- (8) Former Eurovent's seasonal efficiency index. Value not certified by Eurovent from 2019. Reference: base unit, without any accessories

** Basic unit without included accessories

The certified standard performances and data can be verified in <https://www.eurovent-certification.com>

Some voluntary data are not certified (i.e. Noise Level for water source units; SCOP for units with Pdesign >70 KW; SCOP MT values).

ZETA SKY R7 SLN [R32]

			9.2	10.2	12.2	13.2	15.2	17.2
Cooling								
Refrigeration capacity	(1)	kW	97.99	108.59	119.49	138.19	155.79	178.69
Total absorbed power	(1)	kW	29.35	34.55	39.75	41.73	49.33	57.93
EER	(1)		3.33	3.14	3	3.31	3.15	3.08
Eurovent efficiency class	(1)		A	B	B	A	B	B
Compressors								
Compressors/Circuits		n°	2/1	2/1	2/1	2/1	2/1	2/1
Minimum capacity reduction step	(7)	%	50	50	50	50	50	50
Refrigerant charge CH (MCHX)	(3)	kg	10	10	10	13.7	14.5	14.7
Refrigerant charge CH (Cu/Al)	(3)	kg	14.6	15	18	22	22	21.5
Fans								
Quantity		n°	2	2	2	3	3	3
Total air flow rate CH (MCHX)		m³/h	32000	32400	31800	47700	47100	46800
User-side heat exchanger								
Quantity		n°	1	1	1	1	1	1
Water flow rate CH	(1)	m³/h	16.9	18.7	20.6	23.8	26.9	30.8
Pressure drop CH	(1)	kPa	35	29	28	38	33	44
Noise levels								
Sound power lev. SLN vers.	(4)	dB(A)	79	80	82	83	83	83
Sound pressure lev. SLN vers.	(6)	dB(A)	47	48	50	51	51	51
Dimensions and weights**								
Length		mm	3258	3258	3258	4259	4259	4259
Depth		mm	1126	1126	1126	1126	1126	1126
Height		mm	2380	2380	2380	2376	2376	2376
Operating weight		kg	1067	1098	1146	1366	1432	1458

CH: chiller unit; HP: heat pump unit; MCHX: unit with microchannel coils

- (1) External air temperature of 35°C and user-side heat exchanger water inlet-outlet temperature of 12-7°C. Values compliant with standard EN 14511
- (2) Outside air temperature 7°C DB, 6°C WB; condenser inlet/outlet water temperature 40/45°C. Values compliant with standard EN 14511
- (3) Theoretical values referred to the basic unit. The amount of gas actually charged in the unit may differ.
- (4) Unit operating at rated capacity, with no accessories of any kind - external air temperature 35°C and water input/output temperature from/to heat exchanger and user equal to 12/7°C. Values taken by measurements made in accordance with standard ISO 3744 and the Eurovent certification programme, where applicable. Binding values See NOISE LEVELS section.
- (5) unit operating at nominal operating capacity, with no accessories of any kind, with external air temperature of 7°C (6°C WB) and user-side heat exchanger water inlet/outlet temperature of 40/45°C. Values obtained from measurements carried out in accordance with standard ISO 3744.
- (6) Values obtained from the sound power level (conditions: note 4), related to a distance of 10 m from the unit in free field with directivity factor Q=2. Non-binding values See NOISE LEVELS section.
- (7) Approximate value. The minimum capacity reached by the unit depends on the operating conditions. The value shown may not be suitable for calculating the minimum volume of water: to do this, consult the "Minimum water content in the system" section.
- (8) Former Eurovent's seasonal efficiency index. Value not certified by Eurovent from 2019. Reference: base unit, without any accessories

** Basic unit without included accessories

The certified standard performances and data can be verified in <https://www.eurovent-certification.com>

Some voluntary data are not certified (i.e. Noise Level for water source units; SCOP for units with Pdesign >70 KW; SCOP MT values).

ZETA SKY R7 SLN [R32]

			14.4	16.4	18.4	20.4	24.4
Cooling							
Refrigeration capacity	(1)	kW	141.19	167.49	182.29	195.59	226.19
Total absorbed power	(1)	kW	44.03	56.63	61.93	69.63	86.73
EER	(1)		3.2	2.95	2.94	2.8	2.6
Eurovent efficiency class	(1)		A	B	C	C	D
Compressors							
Compressors/Circuits		n°	4/2	4/2	4/2	4/2	4/2
Minimum capacity reduction step	(7)	%	25	25	25	25	25
Refrigerant charge CH (MCHX)	(3)	kg	16.2	16	16.8	16.5	16.8
Refrigerant charge CH (Cu/Al)	(3)	kg	25.4	22.7	24.8	23	23.5
Fans							
Quantity		n°	3	3	3	3	3
Total air flow rate CH (MCHX)		m³/h	46700	47300	47200	46900	47000
User-side heat exchanger							
Quantity		n°	1	1	1	1	1
Water flow rate CH	(1)	m³/h	24.3	28.8	31.4	33.7	39
Pressure drop CH	(1)	kPa	15	21	20	24	22
Noise levels							
Sound power lev. SLN vers.	(4)	dB(A)	80	81	83	85	85
Sound pressure lev. SLN vers.	(6)	dB(A)	48	49	51	53	53
Dimensions and weights**							
Length		mm	4259	4259	4259	4259	4259
Depth		mm	1126	1126	1126	1126	1126
Height		mm	2376	2376	2376	2376	2376
Operating weight		kg	1478	1478	1658	1708	1808

CH: chiller unit; HP: heat pump unit; MCHX: unit with microchannel coils

- (1) External air temperature of 35°C and user-side heat exchanger water inlet-outlet temperature of 12-7°C. Values compliant with standard EN 14511
- (2) Outside air temperature 7°C DB, 6°C WB; condenser inlet/outlet water temperature 40/45°C. Values compliant with standard EN 14511
- (3) Theoretical values referred to the basic unit. The amount of gas actually charged in the unit may differ.
- (4) Unit operating at rated capacity, with no accessories of any kind - external air temperature 35°C and water input/output temperature from/to heat exchanger and user equal to 12/7°C. Values taken by measurements made in accordance with standard ISO 3744 and the Eurovent certification programme, where applicable. Binding values See NOISE LEVELS section.
- (5) unit operating at nominal operating capacity, with no accessories of any kind, with external air temperature of 7°C (6°C WB) and user-side heat exchanger water inlet/outlet temperature of 40/45°C. Values obtained from measurements carried out in accordance with standard ISO 3744.
- (6) Values obtained from the sound power level (conditions: note 4), related to a distance of 10 m from the unit in free field with directivity factor Q=2. Non-binding values See NOISE LEVELS section.
- (7) Approximate value. The minimum capacity reached by the unit depends on the operating conditions. The value shown may not be suitable for calculating the minimum volume of water: to do this, consult the "Minimum water content in the system" section.
- (8) Former Eurovent's seasonal efficiency index. Value not certified by Eurovent from 2019. Reference: base unit, without any accessories

** Basic unit without included accessories

The certified standard performances and data can be verified in <https://www.eurovent-certification.com>

Some voluntary data are not certified (i.e. Noise Level for water source units; SCOP for units with Pdesign >70 KW; SCOP MT values).

ZETA SKY HP R7 [R32]

			3.2	4.2	5.2	6.2	7.2	8.2
Cooling								
Refrigeration capacity	(1)	kW	44.69	49.25	53.23	62.17	75.47	80.88
Total absorbed power	(1)	kW	13.39	15.79	17.39	18.99	22.99	25.19
EER	(1)		3.338	3.12	3.061	3.274	3.283	3.211
Eurovent efficiency class	(1)		A	A	B	A	A	A
Heating								
Heating capacity	(1)	kW	46.09	50.79	54.69	64.09	75.48	81.89
Total absorbed power	(1)	kW	13.49	15.19	16.29	18.79	22.59	24.49
COP	(1)		3.417	3.344	3.358	3.411	3.342	3.344
Eurovent efficiency class	(1)		A	A	A	A	A	A
Compressors								
Compressors/Circuits		n°	2/1	2/1	2/1	2/1	2/1	2/1
Minimum capacity reduction step	(7)	%	50	50	50	50	50	50
Refrigerant charge HP	(3)	kg	8.2	7	7.8	11	11.9	12.4
Fans								
Quantity		n°	2	2	2	2	3	3
Total air flow rate HP		m³/h	18000	18000	18000	20000	28000	28000
User-side heat exchanger								
Quantity		n°	1	1	1	1	1	1
Water flow rate CH	(1)	m³/h	7.7	8.5	9.2	10.7	13	13.9
Pressure drop CH	(1)	kPa	21	25	19	26	22	25
Water flow rate HP	(1)	m³/h	7.9	8.7	9.4	11	13	14.1
Pressure drop HP	(1)	kPa	22	27	20	27	22	25
Noise levels								
Sound power level cooling	(4)	dB(A)	78	79	79	80	81	82
Sound pressure level cooling	(6)	dB(A)	46	48	48	48	49	50
Sound power level of vers. LN cooling	(4)	dB(A)	76	77	77	78	79	80
Sound pressure level of vers. LN cooling	(6)	dB(A)	44	46	46	46	47	48
Dimensions and weights**								
Length		mm	2258	2258	2258	3258	3258	3258
Depth		mm	1030	1030	1030	1134	1134	1134
Height		mm	1799	1799	1799	1799	1799	1799
Operating weight		kg	543	567	578	823	880	883

CH: chiller unit; HP: heat pump unit; MCHX: unit with microchannel coils

- (1) External air temperature of 35°C and user-side heat exchanger water inlet-outlet temperature of 12-7°C. Values compliant with standard EN 14511
- (2) Outside air temperature 7°C DB, 6°C WB; condenser inlet/outlet water temperature 40/45°C. Values compliant with standard EN 14511
- (3) Theoretical values referred to the basic unit. The amount of gas actually charged in the unit may differ.
- (4) Unit operating at rated capacity, with no accessories of any kind - external air temperature 35°C and water input/output temperature from/to heat exchanger and user equal to 12/7°C. Values taken by measurements made in accordance with standard ISO 3744 and the Eurovent certification programme, where applicable. Binding values See NOISE LEVELS section.
- (5) unit operating at nominal operating capacity, with no accessories of any kind, with external air temperature of 7°C (6°C WB) and user-side heat exchanger water inlet/outlet temperature of 40/45°C. Values obtained from measurements carried out in accordance with standard ISO 3744.
- (6) Values obtained from the sound power level (conditions: note 4), related to a distance of 10 m from the unit in free field with directivity factor Q=2. Non-binding values See NOISE LEVELS section.
- (7) Approximate value. The minimum capacity reached by the unit depends on the operating conditions. The value shown may not be suitable for calculating the minimum volume of water: to do this, consult the "Minimum water content in the system" section.

** Basic unit without included accessories

The certified standard performances and data can be verified in <https://www.eurovent-certification.com>

Some voluntary data are not certified (i.e. Noise Level for water source units; SCOP for units with Pdesign >70 KW; SCOP MT values).

ZETA SKY HP R7 [R32]

			9.2	10.2	12.2	13.2	15.2	17.2
Cooling								
Refrigeration capacity	(1)	kW	99.77	110.45	120.36	139.75	157.86	178.56
Total absorbed power	(1)	kW	30.35	33.95	39.75	41.58	48.78	55.87
EER	(1)		3,288	3,254	3,028	3,361	3,237	3,196
Eurovent efficiency class	(1)		A	A	B	A	A	A
Heating								
Heating capacity	(1)	kW	102.19	112.79	123.19	142.49	161.89	182.99
Total absorbed power	(1)	kW	30.45	32.75	35.95	41.88	47.78	54.08
COP	(1)		3,356	3,444	3,427	3,403	3,389	3,384
Eurovent efficiency class	(1)		A	A	A	A	A	A
Compressors								
Compressors/Circuits		n°	2/1	2/1	2/1	2/1	2/1	2/1
Minimum capacity reduction step	(7)	%	50	50	50	50	50	50
Refrigerant charge HP	(3)	kg	16	16.5	17.5	22	22	24.5
Fans								
Quantity		n°	2	2	2	3	3	3
Total air flow rate HP		m³/h	42000	42000	42000	59000	59000	59000
User-side heat exchanger								
Quantity		n°	1	1	1	1	1	1
Water flow rate CH	(1)	m³/h	17.2	19	20.7	24.1	27.2	30.8
Pressure drop CH	(1)	kPa	37	30	29	39	35	44
Water flow rate HP	(1)	m³/h	17.5	19.4	21.1	24.4	27.8	31.4
Pressure drop HP	(1)	kPa	39	32	31	41	37	47
Noise levels								
Sound power level cooling	(4)	dB(A)	83	84	86	87	84	87
Sound pressure level cooling	(6)	dB(A)	51	52	54	55	52	55
Sound power level of vers. LN cooling	(4)	dB(A)	81	82	84	85	82	85
Sound pressure level of vers. LN cooling	(6)	dB(A)	49	50	52	53	50	53
Dimensions and weights**								
Length		mm	3258	3258	3258	4259	4259	4259
Depth		mm	1126	1126	1126	1126	1126	1126
Height		mm	2380	2380	2380	2376	2376	2376
Operating weight		kg	1088	1116	1167	1384	1452	1480

CH: chiller unit; HP: heat pump unit; MCHX: unit with microchannel coils

- (1) External air temperature of 35°C and user-side heat exchanger water inlet-outlet temperature of 12-7°C. Values compliant with standard EN 14511
- (2) Outside air temperature 7°C DB, 6°C WB; condenser inlet/outlet water temperature 40/45°C. Values compliant with standard EN 14511
- (3) Theoretical values referred to the basic unit. The amount of gas actually charged in the unit may differ.
- (4) Unit operating at rated capacity, with no accessories of any kind - external air temperature 35°C and water input/output temperature from/to heat exchanger and user equal to 12/7°C. Values taken by measurements made in accordance with standard ISO 3744 and the Eurovent certification programme, where applicable. Binding values See NOISE LEVELS section.
- (5) unit operating at nominal operating capacity, with no accessories of any kind, with external air temperature of 7°C (6°C WB) and user-side heat exchanger water inlet/outlet temperature of 40/45°C. Values obtained from measurements carried out in accordance with standard ISO 3744.
- (6) Values obtained from the sound power level (conditions: note 4), related to a distance of 10 m from the unit in free field with directivity factor Q=2. Non-binding values See NOISE LEVELS section.
- (7) Approximate value. The minimum capacity reached by the unit depends on the operating conditions. The value shown may not be suitable for calculating the minimum volume of water: to do this, consult the "Minimum water content in the system" section.

** Basic unit without included accessories

The certified standard performances and data can be verified in <https://www.eurovent-certification.com>

Some voluntary data are not certified (i.e. Noise Level for water source units; SCOP for units with Pdesign >70 KW; SCOP MT values).

ZETA SKY HP R7 [R32]

			14.4	16.4	18.4	20.4	24.4
Cooling							
Refrigeration capacity	(1)	kW	142.4	169.97	185.17	203.24	237.66
Total absorbed power	(1)	kW	43.98	55.68	61.18	67.31	81.61
EER	(1)		3.238	3.053	3.027	3.02	2,913
Eurovent efficiency class	(1)		A	B	B	B	C
Heating							
Heating capacity	(1)	kW	148.59	180.29	190.59	207.89	236.09
Total absorbed power	(1)	kW	44.98	55.18	57.98	65.31	74.31
COP	(1)		3,304	3,268	3,288	3.184	3.178
Eurovent efficiency class	(1)		A	A	A	B	B
Compressors							
Compressors/Circuits		n°	4/2	4/2	4/2	4/2	4/2
Minimum capacity reduction step	(7)	%	25	25	25	25	25
Refrigerant charge HP	(3)	kg	23.8	25	26	26.8	28
Fans							
Quantity		n°	3	3	3	4	4
Total air flow rate HP		m³/h	59000	59000	59000	75000	75000
User-side heat exchanger							
Quantity		n°	1	1	1	1	1
Water flow rate CH	(1)	m³/h	24.5	29.3	31.9	35	40.9
Pressure drop CH	(1)	kPa	16	22	21	26	24
Water flow rate HP	(1)	m³/h	25.5	31	32.7	35.7	40.5
Pressure drop HP	(1)	kPa	17	23	23	27	24
Noise levels							
Sound power level cooling	(4)	dB(A)	87	85	87	89	90
Sound pressure level cooling	(6)	dB(A)	55	53	55	57	58
Sound power level of vers. LN cooling	(4)	dB(A)	85	83	85	87	88
Sound pressure level of vers. LN cooling	(6)	dB(A)	53	51	53	55	56
Dimensions and weights**							
Length		mm	4259	4259	4259	4259	4259
Depth		mm	1126	1126	1126	1126	1126
Height		mm	2376	2376	2376	2376	2376
Operating weight		kg	1504	1504	1680	1764	1884

CH: chiller unit; HP: heat pump unit; MCHX: unit with microchannel coils

- (1) External air temperature of 35°C and user-side heat exchanger water inlet-outlet temperature of 12-7°C. Values compliant with standard EN 14511
- (2) Outside air temperature 7°C DB, 6°C WB; condenser inlet/outlet water temperature 40/45°C. Values compliant with standard EN 14511
- (3) Theoretical values referred to the basic unit. The amount of gas actually charged in the unit may differ.
- (4) Unit operating at rated capacity, with no accessories of any kind - external air temperature 35°C and water input/output temperature from/to heat exchanger and user equal to 12/7°C. Values taken by measurements made in accordance with standard ISO 3744 and the Eurovent certification programme, where applicable. Binding values See NOISE LEVELS section.
- (5) unit operating at nominal operating capacity, with no accessories of any kind, with external air temperature of 7°C (6°C WB) and user-side heat exchanger water inlet/outlet temperature of 40/45°C. Values obtained from measurements carried out in accordance with standard ISO 3744.
- (6) Values obtained from the sound power level (conditions: note 4), related to a distance of 10 m from the unit in free field with directivity factor Q=2. Non-binding values See NOISE LEVELS section.
- (7) Approximate value. The minimum capacity reached by the unit depends on the operating conditions. The value shown may not be suitable for calculating the minimum volume of water: to do this, consult the "Minimum water content in the system" section.

** Basic unit without included accessories

The certified standard performances and data can be verified in <https://www.eurovent-certification.com>

Some voluntary data are not certified (i.e. Noise Level for water source units; SCOP for units with Pdesign >70 KW; SCOP MT values).

ZETA SKY HP R7 SLN [R32]

			3.2	4.2	5.2	6.2	7.2	8.2
Cooling								
Refrigeration capacity	(1)	kW	43.39	47.54	51.24	59.55	73.05	77.87
Total absorbed power	(1)	kW	13.79	16.49	18.29	20.1	23.91	26.4
EER	(1)		3.14	2.88	2.8	2.96	3.055	2.95
Eurovent efficiency class	(1)		A	C			B	
Heating								
Heating capacity	(1)	kW	46.09	50.79	54.69	64.09	75.48	81.89
Total absorbed power	(1)	kW	13.49	15.19	16.29	18.79	22.59	24.49
COP	(1)		3.417	3.344	3.358	3.411	3.342	3.344
Eurovent efficiency class	(1)		A					
Compressors								
Compressors/Circuits		n°	2/1					
Minimum capacity reduction step	(7)	%	50					
Refrigerant charge HP	(3)	kg	8.2	7	7.8	11	11.9	12.4
Fans								
Quantity		n°	2				3	
Total air flow rate HP		m³/h	13400	13800		14500	21600	21200
User-side heat exchanger								
Quantity		n°	1					
Water flow rate CH	(1)	m³/h	7.5	8.2	8.8	10.3	12.6	13.4
Pressure drop CH	(1)	kPa	20	24	18	24	20	23
Water flow rate HP	(1)	m³/h	7.9	8.7	9.4	11	13	14.1
Pressure drop HP	(1)	kPa	22	27	20	27	22	25
Noise levels								
Sound power lev. SLN vers.	(4)	dB(A)	74	75		76	77	78
Sound pressure lev. SLN vers.	(6)	dB(A)	42	44			45	46
Dimensions and weights**								
Length		mm	2258			3258		
Depth		mm	1030			1134		
Height		mm	1799					
Operating weight		kg	543	567	578	823	880	883

CH: chiller unit; HP: heat pump unit; MCHX: unit with microchannel coils

- (1) External air temperature of 35°C and user-side heat exchanger water inlet-outlet temperature of 12-7°C. Values compliant with standard EN 14511
 - (2) Outside air temperature 7°C DB, 6°C WB; condenser inlet/outlet water temperature 40/45°C. Values compliant with standard EN 14511
 - (3) Theoretical values referred to the basic unit. The amount of gas actually charged in the unit may differ.
 - (4) Unit operating at rated capacity, with no accessories of any kind - external air temperature 35°C and water input/output temperature from/to heat exchanger and user equal to 12/7°C. Values taken by measurements made in accordance with standard ISO 3744 and the Eurovent certification programme, where applicable. Binding values See NOISE LEVELS section.
 - (5) unit operating at nominal operating capacity, with no accessories of any kind, with external air temperature of 7°C (6°C WB) and user-side heat exchanger water inlet/outlet temperature of 40/45°C. Values obtained from measurements carried out in accordance with standard ISO 3744.
 - (6) Values obtained from the sound power level (conditions: note 4), related to a distance of 10 m from the unit in free field with directivity factor Q=2. Non-binding values See NOISE LEVELS section.
 - (7) Approximate value. The minimum capacity reached by the unit depends on the operating conditions. The value shown may not be suitable for calculating the minimum volume of water: to do this, consult the "Minimum water content in the system" section.
 - (8) Former Eurovent's seasonal efficiency index. Value not certified by Eurovent from 2019. Reference: base unit, without any accessories
- ** Basic unit without included accessories

The certified standard performances and data can be verified in <https://www.eurovent-certification.com>

Some voluntary data are not certified (i.e. Noise Level for water source units; SCOP for units with Pdesign >70 KW; SCOP MT values).

ZETA SKY HP R7 SLN [R32]

			9.2	10.2	12.2	13.2	15.2	17.2
Cooling								
Refrigeration capacity	(1)	kW	96.64	106.92	115.93	136.01	153.12	172.11
Total absorbed power	(1)	kW	30.63	34.97	41.38	42.26	50.26	59.27
EER	(1)		3.155	3.057	2.8	3.22	3.04	2.9
Eurovent efficiency class	(1)		B		C	A	B	C
Heating								
Heating capacity	(1)	kW	102.19	112.79	123.19	142.49	161.89	182.99
Total absorbed power	(1)	kW	30.45	32.75	35.95	41.88	47.78	54.08
COP	(1)		3.356	3.444	3.427	3.403	3.389	3.384
Eurovent efficiency class	(1)		A					
Compressors								
Compressors/Circuits		n°	2/1					
Minimum capacity reduction step	(7)	%	50					
Refrigerant charge HP	(3)	kg	16	16.5	17.5	22		24.5
Fans								
Quantity		n°	2			3		
Total air flow rate HP		m³/h	32000	32400	31800	47700	47100	46800
User-side heat exchanger								
Quantity		n°	1					
Water flow rate CH	(1)	m³/h	16.7	18.4	20	23.5	26.4	29.7
Pressure drop CH	(1)	kPa	35	28	27	37	33	41
Water flow rate HP	(1)	m³/h	17.5	19.4	21.1	24.4	27.8	31.4
Pressure drop HP	(1)	kPa	39	32	31	41	37	47
Noise levels								
Sound power lev. SLN vers.	(4)	dB(A)	79	80	82	83		
Sound pressure lev. SLN vers.	(6)	dB(A)	47	48	50	51		
Dimensions and weights**								
Length		mm	3258			4259		
Depth		mm	1126					
Height		mm	2380			2376		
Operating weight		kg	1088	1116	1167	1384	1452	1480

CH: chiller unit; HP: heat pump unit; MCHX: unit with microchannel coils

- (1) External air temperature of 35°C and user-side heat exchanger water inlet-outlet temperature of 12-7°C. Values compliant with standard EN 14511
 - (2) Outside air temperature 7°C DB, 6°C WB; condenser inlet/outlet water temperature 40/45°C. Values compliant with standard EN 14511
 - (3) Theoretical values referred to the basic unit. The amount of gas actually charged in the unit may differ.
 - (4) Unit operating at rated capacity, with no accessories of any kind - external air temperature 35°C and water input/output temperature from/to heat exchanger and user equal to 12/7°C. Values taken by measurements made in accordance with standard ISO 3744 and the Eurovent certification programme, where applicable. Binding values See NOISE LEVELS section.
 - (5) unit operating at nominal operating capacity, with no accessories of any kind, with external air temperature of 7°C (6°C WB) and user-side heat exchanger water inlet/outlet temperature of 40/45°C. Values obtained from measurements carried out in accordance with standard ISO 3744.
 - (6) Values obtained from the sound power level (conditions: note 4), related to a distance of 10 m from the unit in free field with directivity factor Q=2. Non-binding values See NOISE LEVELS section.
 - (7) Approximate value. The minimum capacity reached by the unit depends on the operating conditions. The value shown may not be suitable for calculating the minimum volume of water: to do this, consult the "Minimum water content in the system" section.
 - (8) Former Eurovent's seasonal efficiency index. Value not certified by Eurovent from 2019. Reference: base unit, without any accessories
- ** Basic unit without included accessories

The certified standard performances and data can be verified in <https://www.eurovent-certification.com>

Some voluntary data are not certified (i.e. Noise Level for water source units; SCOP for units with Pdesign >70 KW; SCOP MT values).

ZETA SKY HP R7 SLN [R32]

			14.4	16.4	18.4	20.4	24.4
Cooling							
Refrigeration capacity	(1)	kW	138.58	164.23	178.15	195	225.9
Total absorbed power	(1)	kW	44.84	57.56	63.75	70.97	87.27
EER	(1)		3.09	2.85	2.79	2.74	2.59
Eurovent efficiency class	(1)		B		C		D
Heating							
Heating capacity	(1)	kW	148.59	180.29	190.59	207.89	236.09
Total absorbed power	(1)	kW	44.98	55.18	57.98	65.31	74.31
COP	(1)		3.304	3.268	3.288	3.184	3.178
Eurovent efficiency class	(1)			A			B
Compressors							
Compressors/Circuits		n°			4/2		
Minimum capacity reduction step	(7)	%			25		
Refrigerant charge HP	(3)	kg	23.8	25	26	26.8	28
Fans							
Quantity		n°		3			4
Total air flow rate HP		m³/h	46700	47300	47200	46900	47000
User-side heat exchanger							
Quantity		n°			1		
Water flow rate CH	(1)	m³/h	23.9	28.3	30.7	33.6	38.9
Pressure drop CH	(1)	kPa	15		20	24	22
Water flow rate HP	(1)	m³/h	25.5	31	32.7	35.7	40.5
Pressure drop HP	(1)	kPa	17		23	27	24
Noise levels							
Sound power lev. SLN vers.	(4)	dB(A)	80	81	83		86
Sound pressure lev. SLN vers.	(6)	dB(A)	48	49	51		54
Dimensions and weights**							
Length		mm			4259		
Depth		mm			1126		
Height		mm			2376		
Operating weight		kg		1504	1680	1764	1884

CH: chiller unit; HP: heat pump unit; MCHX: unit with microchannel coils

- (1) External air temperature of 35°C and user-side heat exchanger water inlet-outlet temperature of 12-7°C. Values compliant with standard EN 14511
(2) Outside air temperature 7°C DB, 6°C WB; condenser inlet/outlet water temperature 40/45°C. Values compliant with standard EN 14511
(3) Theoretical values referred to the basic unit. The amount of gas actually charged in the unit may differ.
(4) Unit operating at rated capacity, with no accessories of any kind - external air temperature 35°C and water input/output temperature from/to heat exchanger and user equal to 12/7°C. Values taken by measurements made in accordance with standard ISO 3744 and the Eurovent certification programme, where applicable. Binding values See NOISE LEVELS section.
(5) unit operating at nominal operating capacity, with no accessories of any kind, with external air temperature of 7°C (6°C WB) and user-side heat exchanger water inlet/outlet temperature of 40/45°C. Values obtained from measurements carried out in accordance with standard ISO 3744.
(6) Values obtained from the sound power level (conditions: note 4), related to a distance of 10 m from the unit in free field with directivity factor Q=2. Non-binding values See NOISE LEVELS section.
(7) Approximate value. The minimum capacity reached by the unit depends on the operating conditions. The value shown may not be suitable for calculating the minimum volume of water: to do this, consult the "Minimum water content in the system" section.
(8) Former Eurovent's seasonal efficiency index. Value not certified by Eurovent from 2019. Reference: base unit, without any accessories
** Basic unit without included accessories

The certified standard performances and data can be verified in <https://www.eurovent-certification.com>

Some voluntary data are not certified (i.e. Noise Level for water source units; SCOP for units with Pdesign >70 KW; SCOP MT values).

ZETA SKY HP R5 [R454B]

			3.2	4.2	5.2	6.2	7.2	8.2
Cooling								
Refrigeration capacity	(1)	kW	42.39	48.75	52.04	59.96	73.96	80.58
Total absorbed power	(1)	kW	13.39	15.69	16.59	18.39	22.39	25.39
EER	(1)		3.16	3.1	3.13	3.26	3.3	3.17
Eurovent efficiency class	(1)		A					
Heating								
Heating capacity	(1)	kW	44.09	50.79	53.69	61.39	73.79	81.49
Total absorbed power	(1)	kW	13.69	15.49	16.29	18.39	21.79	24.29
COP	(1)		3.22	3.27	3.29	3.33	3.38	3.35
Eurovent efficiency class	(1)		A					
Compressors								
Compressors/Circuits		n°	2/1					
Minimum capacity reduction step	(7)	%	50					
Refrigerant charge HP	(3)	kg	9	10	12.5	13.3	13.5	
Fans								
Quantity		n°	2			3		
Total air flow rate HP		m³/h	18000			20000	28000	
User-side heat exchanger								
Quantity		n°	1					
Water flow rate CH	(1)	m³/h	7.3	8.4	9	10.3	12.7	13.9
Pressure drop CH	(1)	kPa	19	25	18	24	21	24
Water flow rate HP	(1)	m³/h	7.6	8.7	9.2	10.5	12.7	14
Pressure drop HP	(1)	kPa	20	27	19	25	21	25
Noise levels								
Sound power level cooling	(4)	dB(A)	78	79		80	81	82
Sound pressure level cooling	(6)	dB(A)	46	48			49	50
Sound power level of vers. LN cooling	(4)	dB(A)	76	77		78	79	80
Sound pressure level of vers. LN cooling	(6)	dB(A)	44	46			47	48
Dimensions and weights**								
Length		mm	2258			3258		
Depth		mm	1030			1134		
Height		mm	1799					
Operating weight		kg	583	604	616	830	888	894

CH: chiller unit; HP: heat pump unit; MCHX: unit with microchannel coils

- (1) External air temperature of 35°C and user-side heat exchanger water inlet-outlet temperature of 12-7°C. Values compliant with standard EN 14511
- (2) Outside air temperature 7°C DB, 6°C WB; condenser inlet/outlet water temperature 40/45°C. Values compliant with standard EN 14511
- (3) Theoretical values referred to the basic unit. The amount of gas actually charged in the unit may differ.
- (4) Unit operating at rated capacity, with no accessories of any kind - external air temperature 35°C and water input/output temperature from/to heat exchanger and user equal to 12/7°C. Values taken by measurements made in accordance with standard ISO 3744 and the Eurovent certification programme, where applicable. Binding values See NOISE LEVELS section.
- (5) unit operating at nominal operating capacity, with no accessories of any kind, with external air temperature of 7°C (6°C WB) and user-side heat exchanger water inlet/outlet temperature of 40/45°C. Values obtained from measurements carried out in accordance with standard ISO 3744.
- (6) Values obtained from the sound power level (conditions: note 4), related to a distance of 10 m from the unit in free field with directivity factor Q=2. Non-binding values See NOISE LEVELS section.
- (7) Approximate value. The minimum capacity reached by the unit depends on the operating conditions. The value shown may not be suitable for calculating the minimum volume of water: to do this, consult the "Minimum water content in the system" section.

** Basic unit without included accessories

The certified standard performances and data can be verified in <https://www.eurovent-certification.com>

Some voluntary data are not certified (i.e. Noise Level for water source units; SCOP for units with Pdesign >70 KW; SCOP MT values).

ZETA SKY HP R5 [R454B]

			9.2	10.2	12.2	13.2	15.2	17.2
Cooling								
Refrigeration capacity	(1)	kW	96.85	110.45	126.98	135.03	167.41	185.11
Total absorbed power	(1)	kW	29.45	34.45	43.65	41.18	54.89	61.18
EER	(1)		3.28	3.2	2.91	3.28	3.05	3.02
Eurovent efficiency class	(1)		A		C	A	B	
Heating								
Heating capacity	(1)	kW	99.39	112.09	133.79	138.59	174.79	189.49
Total absorbed power	(1)	kW	29.95	33.55	40.05	41.78	52.58	58.18
COP	(1)		3.31	3.34		3.31	3.32	3.25
Eurovent efficiency class	(1)		A					B
Compressors								
Compressors/Circuits		n°	2/1					
Minimum capacity reduction step	(7)	%	50					
Refrigerant charge HP	(3)	kg	19		20		28	28.5
Fans								
Quantity		n°	2			3		
Total air flow rate HP		m³/h	42000			59000		
User-side heat exchanger								
Quantity		n°	1					
Water flow rate CH	(1)	m³/h	16.7	19	21.9	23.3	28.8	31.9
Pressure drop CH	(1)	kPa	35	30	32	37	41	48
Water flow rate HP	(1)	m³/h	17.1	19.2	23	23.8	30	32.5
Pressure drop HP	(1)	kPa	37	31	36	39	42	49
Noise levels								
Sound power level cooling	(4)	dB(A)	83	84	86	87	84	87
Sound pressure level cooling	(6)	dB(A)	51	52	54	55	52	55
Sound power level of vers. LN cooling	(4)	dB(A)	81	82	84	85	82	85
Sound pressure level of vers. LN cooling	(6)	dB(A)	49	50	52	53	50	53
Dimensions and weights**								
Length		mm	3258			4259		
Depth		mm	1126					
Height		mm	2380			2376		
Operating weight		kg	1102	1128	1185	1406	1474	1508

CH: chiller unit; HP: heat pump unit; MCHX: unit with microchannel coils

- (1) External air temperature of 35°C and user-side heat exchanger water inlet-outlet temperature of 12-7°C. Values compliant with standard EN 14511
- (2) Outside air temperature 7°C DB, 6°C WB; condenser inlet/outlet water temperature 40/45°C. Values compliant with standard EN 14511
- (3) Theoretical values referred to the basic unit. The amount of gas actually charged in the unit may differ.
- (4) Unit operating at rated capacity, with no accessories of any kind - external air temperature 35°C and water input/output temperature from/to heat exchanger and user equal to 12/7°C. Values taken by measurements made in accordance with standard ISO 3744 and the Eurovent certification programme, where applicable. Binding values See NOISE LEVELS section.
- (5) unit operating at nominal operating capacity, with no accessories of any kind, with external air temperature of 7°C (6°C WB) and user-side heat exchanger water inlet/outlet temperature of 40/45°C. Values obtained from measurements carried out in accordance with standard ISO 3744.
- (6) Values obtained from the sound power level (conditions: note 4), related to a distance of 10 m from the unit in free field with directivity factor Q=2. Non-binding values See NOISE LEVELS section.
- (7) Approximate value. The minimum capacity reached by the unit depends on the operating conditions. The value shown may not be suitable for calculating the minimum volume of water: to do this, consult the "Minimum water content in the system" section.

** Basic unit without included accessories

The certified standard performances and data can be verified in <https://www.eurovent-certification.com>

Some voluntary data are not certified (i.e. Noise Level for water source units; SCOP for units with Pdesign >70 KW; SCOP MT values).

ZETA SKY HP R5 [R454B]

			14.4	16.4	18.4	20.4	24.4
Cooling							
Refrigeration capacity	(1)	kW	147.81	172.07	185.38	211.67	233.35
Total absorbed power	(1)	kW	45.58	57.08	62.68	73.61	82.71
EER	(1)		3.24	3.01	2.95	2.87	2.82
Eurovent efficiency class	(1)		A	B		C	
Heating							
Heating capacity	(1)	kW	151.09	180.29	192.09	210.89	229.39
Total absorbed power	(1)	kW	45.58	54.98	58.48	69.11	74.51
COP	(1)		3.31	3.28		3.05	3.07
Eurovent efficiency class	(1)		A		C		B
Compressors							
Compressors/Circuits		n°	4/2				
Minimum capacity reduction step	(7)	%	25				
Refrigerant charge HP	(3)	kg	29	32		33	38
Fans							
Quantity		n°	3			4	
Total air flow rate HP		m³/h	59000			75000	
User-side heat exchanger							
Quantity		n°	1				
Water flow rate CH	(1)	m³/h	25.5	29.6	31.9	36.5	40.2
Pressure drop CH	(1)	kPa	17	22		28	24
Water flow rate HP	(1)	m³/h	26	31	33	36.2	39.4
Pressure drop HP	(1)	kPa	17	23	22	28	23
Noise levels							
Sound power level cooling	(4)	dB(A)	87	85	87	89	90
Sound pressure level cooling	(6)	dB(A)	55	53	55	57	58
Sound power level of vers. LN cooling	(4)	dB(A)	85	83	85	87	88
Sound pressure level of vers. LN cooling	(6)	dB(A)	53	51	53	55	56
Dimensions and weights**							
Length		mm	4259				
Depth		mm	1126				
Height		mm	2376				
Operating weight		kg	1524	1700		1834	1922

CH: chiller unit; HP: heat pump unit; MCHX: unit with microchannel coils

- (1) External air temperature of 35°C and user-side heat exchanger water inlet-outlet temperature of 12-7°C. Values compliant with standard EN 14511
- (2) Outside air temperature 7°C DB, 6°C WB; condenser inlet/outlet water temperature 40/45°C. Values compliant with standard EN 14511
- (3) Theoretical values referred to the basic unit. The amount of gas actually charged in the unit may differ.
- (4) Unit operating at rated capacity, with no accessories of any kind - external air temperature 35°C and water input/output temperature from/to heat exchanger and user equal to 12/7°C. Values taken by measurements made in accordance with standard ISO 3744 and the Eurovent certification programme, where applicable. Binding values See NOISE LEVELS section.
- (5) unit operating at nominal operating capacity, with no accessories of any kind, with external air temperature of 7°C (6°C WB) and user-side heat exchanger water inlet/outlet temperature of 40/45°C. Values obtained from measurements carried out in accordance with standard ISO 3744.
- (6) Values obtained from the sound power level (conditions: note 4), related to a distance of 10 m from the unit in free field with directivity factor Q=2. Non-binding values See NOISE LEVELS section.
- (7) Approximate value. The minimum capacity reached by the unit depends on the operating conditions. The value shown may not be suitable for calculating the minimum volume of water: to do this, consult the "Minimum water content in the system" section.

** Basic unit without included accessories

The certified standard performances and data can be verified in <https://www.eurovent-certification.com>

Some voluntary data are not certified (i.e. Noise Level for water source units; SCOP for units with Pdesign >70 KW; SCOP MT values).

ZETA SKY HP R5 SLN [R454B]

			3.2	4.2	5.2	6.2	7.2	8.2
Cooling								
Refrigeration capacity	(1)	kW	41.19	47.04	50.03	57.45	71.55	77.68
Total absorbed power	(1)	kW	13.89	16.39	17.69	19.39	23.19	26.59
EER	(1)		2.96	2.87	2.82	2.96	3.08	2.92
Eurovent efficiency class	(1)		B	C	C	B	B	B
Heating								
Heating capacity	(1)	kW	44.09	50.79	53.69	61.39	73.79	81.49
Total absorbed power	(1)	kW	13.69	15.49	16.29	18.39	21.79	24.29
COP	(1)		3.22	3.27	3.29	3.33	3.38	3.35
Eurovent efficiency class	(1)		A	A	A	A	A	A
Compressors								
Compressors/Circuits		n°	2/1	2/1	2/1	2/1	2/1	2/1
Minimum capacity reduction step	(7)	%	50	50	50	50	50	50
Refrigerant charge HP	(3)	kg	9	9	10	12.5	13.3	13.5
Fans								
Quantity		n°	2	2	2	2	3	3
Total air flow rate HP		m³/h	13500	13400	13600	15400	21500	21200
User-side heat exchanger								
Quantity		n°	1	1	1	1	1	1
Water flow rate CH	(1)	m³/h	7.1	8.1	8.6	9.9	12.3	13.4
Pressure drop CH	(1)	kPa	18	23	17	22	19	23
Water flow rate HP	(1)	m³/h	7.6	8.7	9.2	10.5	12.7	14
Pressure drop HP	(1)	kPa	20	27	19	25	21	25
Noise levels								
Sound power lev. SLN vers.	(4)	dB(A)	74	75	75	76	77	78
Sound pressure lev. SLN vers.	(6)	dB(A)	42	44	44	44	45	46
Dimensions and weights**								
Length		mm	2200	2200	2200	3200	3200	3200
Depth		mm	1000	1000	1000	1100	1100	1100
Height		mm	1799	1799	1799	1799	1799	1799
Operating weight		kg	583	604	616	830	888	894

CH: chiller unit; HP: heat pump unit; MCHX: unit with microchannel coils

- (1) External air temperature of 35°C and user-side heat exchanger water inlet-outlet temperature of 12-7°C. Values compliant with standard EN 14511
 - (2) Outside air temperature 7°C DB, 6°C WB; condenser inlet/outlet water temperature 40/45°C. Values compliant with standard EN 14511
 - (3) Theoretical values referred to the basic unit. The amount of gas actually charged in the unit may differ.
 - (4) Unit operating at rated capacity, with no accessories of any kind - external air temperature 35°C and water input/output temperature from/to heat exchanger and user equal to 12/7°C. Values taken by measurements made in accordance with standard ISO 3744 and the Eurovent certification programme, where applicable. Binding values See NOISE LEVELS section.
 - (5) unit operating at nominal operating capacity, with no accessories of any kind, with external air temperature of 7°C (6°C WB) and user-side heat exchanger water inlet/outlet temperature of 40/45°C. Values obtained from measurements carried out in accordance with standard ISO 3744.
 - (6) Values obtained from the sound power level (conditions: note 4), related to a distance of 10 m from the unit in free field with directivity factor Q=2. Non-binding values See NOISE LEVELS section.
 - (7) Approximate value. The minimum capacity reached by the unit depends on the operating conditions. The value shown may not be suitable for calculating the minimum volume of water: to do this, consult the "Minimum water content in the system" section.
 - (8) Former Eurovent's seasonal efficiency index. Value not certified by Eurovent from 2019. Reference: base unit, without any accessories
- ** Basic unit without included accessories

The certified standard performances and data can be verified in <https://www.eurovent-certification.com>

Some voluntary data are not certified (i.e. Noise Level for water source units; SCOP for units with Pdesign >70 KW; SCOP MT values).

ZETA SKY HP R5 SLN [R454B]

			9.2	10.2	12.2	13.2	15.2	17.2
Cooling								
Refrigeration capacity	(1)	kW	93.94	106.94	122.27	131.41	167.18	178.46
Total absorbed power	(1)	kW	30.45	35.45	45.35	41.83	57.03	64.83
EER	(1)		3.08	3.01	2.69	3.14	2.93	2.75
Eurovent efficiency class	(1)		B	B	D	B	C	C
Heating								
Heating capacity	(1)	kW	99.39	112.09	133.79	138.59	174.79	189.49
Total absorbed power	(1)	kW	29.95	33.55	40.05	41.78	52.58	58.18
COP	(1)		3.31	3.34	3.34	3.31	3.32	3.25
Eurovent efficiency class	(1)		A	A	A	A	A	B
Compressors								
Compressors/Circuits		n°	2/1	2/1	2/1	2/1	2/1	2/1
Minimum capacity reduction step	(7)	%	50	50	50	50	50	50
Refrigerant charge HP	(3)	kg	19	19	20	28	28	28.5
Fans								
Quantity		n°	2	2	2	3	3	3
Total air flow rate HP		m³/h	32000	31900	32300	43900	44800	43700
User-side heat exchanger								
Quantity		n°	1	1	1	1	1	1
Water flow rate CH	(1)	m³/h	16.2	18.4	21.1	22.7	28.8	30.8
Pressure drop CH	(1)	kPa	33	28	30	35	39	44
Water flow rate HP	(1)	m³/h	17.1	19.2	23	23.8	30	32.5
Pressure drop HP	(1)	kPa	37	31	36	39	42	49
Noise levels								
Sound power lev. SLN vers.	(4)	dB(A)	79	80	82	83	83	83
Sound pressure lev. SLN vers.	(6)	dB(A)	47	48	50	51	51	51
Dimensions and weights**								
Length		mm	3200	3200	3200	4200	4200	4200
Depth		mm	1100	1100	1100	1100	1100	1100
Height		mm	2380	2380	2380	2380	2380	2380
Operating weight		kg	1102	1128	1185	1406	1474	1508

CH: chiller unit; HP: heat pump unit; MCHX: unit with microchannel coils

- (1) External air temperature of 35°C and user-side heat exchanger water inlet-outlet temperature of 12-7°C. Values compliant with standard EN 14511
 - (2) Outside air temperature 7°C DB, 6°C WB; condenser inlet/outlet water temperature 40/45°C. Values compliant with standard EN 14511
 - (3) Theoretical values referred to the basic unit. The amount of gas actually charged in the unit may differ.
 - (4) Unit operating at rated capacity, with no accessories of any kind - external air temperature 35°C and water input/output temperature from/to heat exchanger and user equal to 12/7°C. Values taken by measurements made in accordance with standard ISO 3744 and the Eurovent certification programme, where applicable. Binding values See NOISE LEVELS section.
 - (5) unit operating at nominal operating capacity, with no accessories of any kind, with external air temperature of 7°C (6°C WB) and user-side heat exchanger water inlet/outlet temperature of 40/45°C. Values obtained from measurements carried out in accordance with standard ISO 3744.
 - (6) Values obtained from the sound power level (conditions: note 4), related to a distance of 10 m from the unit in free field with directivity factor Q=2. Non-binding values See NOISE LEVELS section.
 - (7) Approximate value. The minimum capacity reached by the unit depends on the operating conditions. The value shown may not be suitable for calculating the minimum volume of water: to do this, consult the "Minimum water content in the system" section.
 - (8) Former Eurovent's seasonal efficiency index. Value not certified by Eurovent from 2019. Reference: base unit, without any accessories
- ** Basic unit without included accessories

The certified standard performances and data can be verified in <https://www.eurovent-certification.com>

Some voluntary data are not certified (i.e. Noise Level for water source units; SCOP for units with Pdesign >70 KW; SCOP MT values).

ZETA SKY HP R5 SLN [R454B]

			14.4	16.4	18.4	20.4	24.4
Cooling							
Refrigeration capacity	(1)	kW	143.8	166.36	178.36	203.04	221.81
Total absorbed power	(1)	kW	46.53	59.03	65.23	77.21	88.01
EER	(1)		3.09	2.81	2.73	2.63	2.52
Eurovent efficiency class	(1)		B	C	D	D	E
Heating							
Heating capacity	(1)	kW	151.09	180.29	192.09	210.89	229.39
Total absorbed power	(1)	kW	45.58	54.98	58.48	69.11	74.51
COP	(1)		3.31	3.28	3.28	3.05	3.07
Eurovent efficiency class	(1)		A	A	A	C	B
Compressors							
Compressors/Circuits		n°	4/2	4/2	4/2	4/2	4/2
Minimum capacity reduction step	(7)	%	25	25	25	25	25
Refrigerant charge HP	(3)	kg	29	29	32	33	38
Fans							
Quantity		n°	3	3	3	4	4
Total air flow rate HP		m³/h	45500	44800	43900	56500	57400
User-side heat exchanger							
Quantity		n°	1	1	1	1	1
Water flow rate CH	(1)	m³/h	24.8	28.7	30.7	35	38.2
Pressure drop CH	(1)	kPa	16	21	20	26	21
Water flow rate HP	(1)	m³/h	26	31	33	36.2	39.4
Pressure drop HP	(1)	kPa	17	23	22	28	23
Noise levels							
Sound power lev. SLN vers.	(4)	dB(A)	80	81	83	84	85
Sound pressure lev. SLN vers.	(6)	dB(A)	48	49	51	51	52
Dimensions and weights**							
Length		mm	4200	4200	4200	4200	4200
Depth		mm	1100	1100	1100	1100	1100
Height		mm	2380	2380	2380	2380	2380
Operating weight		kg	1524	1524	1700	1834	1922

CH: chiller unit; HP: heat pump unit; MCHX: unit with microchannel coils

- (1) External air temperature of 35°C and user-side heat exchanger water inlet-outlet temperature of 12-7°C. Values compliant with standard EN 14511
 - (2) Outside air temperature 7°C DB, 6°C WB; condenser inlet/outlet water temperature 40/45°C. Values compliant with standard EN 14511
 - (3) Theoretical values referred to the basic unit. The amount of gas actually charged in the unit may differ.
 - (4) Unit operating at rated capacity, with no accessories of any kind - external air temperature 35°C and water input/output temperature from/to heat exchanger and user equal to 12/7°C. Values taken by measurements made in accordance with standard ISO 3744 and the Eurovent certification programme, where applicable. Binding values See NOISE LEVELS section.
 - (5) unit operating at nominal operating capacity, with no accessories of any kind, with external air temperature of 7°C (6°C WB) and user-side heat exchanger water inlet/outlet temperature of 40/45°C. Values obtained from measurements carried out in accordance with standard ISO 3744.
 - (6) Values obtained from the sound power level (conditions: note 4), related to a distance of 10 m from the unit in free field with directivity factor Q=2. Non-binding values See NOISE LEVELS section.
 - (7) Approximate value. The minimum capacity reached by the unit depends on the operating conditions. The value shown may not be suitable for calculating the minimum volume of water: to do this, consult the "Minimum water content in the system" section.
 - (8) Former Eurovent's seasonal efficiency index. Value not certified by Eurovent from 2019. Reference: base unit, without any accessories
- ** Basic unit without included accessories

The certified standard performances and data can be verified in <https://www.eurovent-certification.com>

Some voluntary data are not certified (i.e. Noise Level for water source units; SCOP for units with Pdesign >70 KW; SCOP MT values).

ZETA SKY Hi R7 [R32]

			3.1	4.1	6.2	8.2	10.2	12.2
Cooling								
Refrigeration capacity	(1)	kW	33.49	43.02	63.36	80.39	102.02	124.16
Total absorbed power	(1)	kW	10.99	14.89	21.89	27.01	33.11	41.14
EER	(1)		3.05	2.89	2.9	2.98	3.08	3.02
Eurovent efficiency class	(1)		B	C	C	B	B	B
Compressors								
Compressors/Circuits		n°	1/1	1/1	2/1	2/1	2/1	2/1
Minimum capacity reduction step	(7)	%	22	25	20	15	20	16
Refrigerant charge CH (MCHX)	(3)	kg	3.5	3.5	5	7.2	9.3	9.5
Refrigerant charge CH (Cu/Al)	(3)	kg	6	6	8.3	11.3	15.8	16
Fans								
Quantity		n°	2	2	3	3	2	2
Total air flow rate CH (MCHX)		m³/h	17000	17000	27000	30000	43000	43000
User-side heat exchanger								
Quantity		n°	1	1	1	1	1	1
Water flow rate CH	(1)	m³/h	5.8	7.4	10.9	13.8	17.5	21.3
Pressure drop CH	(1)	kPa	19	19	23	26	26	28
Noise levels								
Sound power level cooling	(4)	dB(A)	83	83	85	85	88	88
Sound pressure level cooling	(6)	dB(A)	51	51	53	53	56	56
Dimensions and weights**								
Length		mm	1750	1750	2539	3258	3258	3258
Depth		mm	1018	1018	1018	1153	1153	1153
Height		mm	1450	1450	1788	1788	2400	2400
Operating weight		kg	514	523	833	971	1052	1104

CH: chiller unit; HP: heat pump unit; MCHX: unit with microchannel coils

- (1) External air temperature of 35°C and user-side heat exchanger water inlet-outlet temperature of 12-7°C. Values compliant with standard EN 14511
- (2) Outside air temperature 7°C DB, 6°C WB; condenser inlet/outlet water temperature 40/45°C. Values compliant with standard EN 14511
- (3) Theoretical values referred to the basic unit. The amount of gas actually charged in the unit may differ.
- (4) Unit operating at rated capacity, with no accessories of any kind - external air temperature 35°C and water input/output temperature from/to heat exchanger and user equal to 12/7°C. Values taken by measurements made in accordance with standard ISO 3744 and the Eurovent certification programme, where applicable. Binding values See NOISE LEVELS section.
- (5) unit operating at nominal operating capacity, with no accessories of any kind, with external air temperature of 7°C (6°C WB) and user-side heat exchanger water inlet/outlet temperature of 40/45°C. Values obtained from measurements carried out in accordance with standard ISO 3744.
- (6) Values obtained from the sound power level (conditions: note 4), related to a distance of 10 m from the unit in free field with directivity factor Q=2. Non-binding values See NOISE LEVELS section.
- (7) Approximate value. The minimum capacity reached by the unit depends on the operating conditions. The value shown may not be suitable for calculating the minimum volume of water: to do this, consult the "Minimum water content in the system" section.
- (8) Former Eurovent's seasonal efficiency index. Value not certified by Eurovent from 2019. Reference: base unit, without any accessories

** Basic unit without included accessories

The certified standard performances and data can be verified in <https://www.eurovent-certification.com>

Some voluntary data are not certified (i.e. Noise Level for water source units; SCOP for units with Pdesign >70 KW; SCOP MT values).

ZETA SKY Hi R7 SLN [R32]

			3.1	4.1	6.2	8.2	10.2	12.2
Cooling								
Refrigeration capacity	(1)	kW	32.59	41.52	62.06	78.87	99.8	120.43
Total absorbed power	(1)	kW	11.29	14.59	21.69	26.79	33.05	41.25
EER	(1)		2.89	2.85	2.86	2.95	3.02	2.92
Eurovent efficiency class	(1)		C	C	C	B	B	C
Compressors								
Compressors/Circuits		n°	1/1	1/1	2/1	2/1	2/1	2/1
Minimum capacity reduction step	(7)	%	22	25	20	15	20	16
Refrigerant charge CH (MCHX)	(3)	kg	3.5	3.5	5	7.2	9.3	9.5
Refrigerant charge CH (Cu/Al)	(3)	kg	6	6	8.3	11.3	15.8	16
Fans								
Quantity		n°	2	2	3	3	2	2
Total air flow rate CH (MCHX)		m³/h	12200	12400	19500	22400	32000	32300
User-side heat exchanger								
Quantity		n°	1	1	1	1	1	1
Water flow rate CH	(1)	m³/h	5.6	7.1	10.7	13.6	17.1	20.7
Pressure drop CH	(1)	kPa	17	17	21	22	23	24
Noise levels								
Sound power lev. SLN vers.	(4)	dB(A)	81	81	83	83	83	83
Sound pressure lev. SLN vers.	(6)	dB(A)	49	49	51	51	51	51
Dimensions and weights**								
Length		mm	1750	1750	2539	3258	3258	3258
Depth		mm	1018	1018	1018	1153	1153	1153
Height		mm	1450	1450	1788	1788	2400	2400
Operating weight		kg	514	523	833	971	1052	1104

CH: chiller unit; HP: heat pump unit; MCHX: unit with microchannel coils

- (1) External air temperature of 35°C and user-side heat exchanger water inlet-outlet temperature of 12-7°C. Values compliant with standard EN 14511
- (2) Outside air temperature 7°C DB, 6°C WB; condenser inlet/outlet water temperature 40/45°C. Values compliant with standard EN 14511
- (3) Theoretical values referred to the basic unit. The amount of gas actually charged in the unit may differ.
- (4) Unit operating at rated capacity, with no accessories of any kind - external air temperature 35°C and water input/output temperature from/to heat exchanger and user equal to 12/7°C. Values taken by measurements made in accordance with standard ISO 3744 and the Eurovent certification programme, where applicable. Binding values See NOISE LEVELS section.
- (5) unit operating at nominal operating capacity, with no accessories of any kind, with external air temperature of 7°C (6°C WB) and user-side heat exchanger water inlet/outlet temperature of 40/45°C. Values obtained from measurements carried out in accordance with standard ISO 3744.
- (6) Values obtained from the sound power level (conditions: note 4), related to a distance of 10 m from the unit in free field with directivity factor Q=2. Non-binding values See NOISE LEVELS section.
- (7) Approximate value. The minimum capacity reached by the unit depends on the operating conditions. The value shown may not be suitable for calculating the minimum volume of water: to do this, consult the "Minimum water content in the system" section.
- (8) Former Eurovent's seasonal efficiency index. Value not certified by Eurovent from 2019. Reference: base unit, without any accessories

** Basic unit without included accessories

The certified standard performances and data can be verified in <https://www.eurovent-certification.com>

Some voluntary data are not certified (i.e. Noise Level for water source units; SCOP for units with Pdesign >70 KW; SCOP MT values).

ZETA SKY Hi HP R7 [R32]

			3.1	4.1	6.2	8.2	10.2	12.2
Cooling								
Refrigeration capacity	(1)	kW	33.39	43.23	63.66	81.89	102.91	121.53
Total absorbed power	(1)	kW	11.39	14.89	21.89	27	33.05	41.05
EER	(1)		2.93	2.9	2.91	3.03	3.11	2.96
Heating								
Heating capacity	(1)	kW	35.38	43.88	65.68	83.58	104.07	124.78
Total absorbed power	(1)	kW	11.28	13.68	20.88	25.87	33.03	38.24
COP	(1)		3.14	3.21	3.15	3.23	3.15	3.26
Compressors								
Compressors/Circuits		n°	1/1	1/1	2/1	2/1	2/1	2/1
Minimum capacity reduction step	(7)	%	22	25	20	15	20	16
Refrigerant charge HP	(3)	kg	5	5.7	8.6	11.7	15	16
Fans								
Quantity		n°	2	2	3	3	2	2
Total air flow rate HP		m³/h	16000	16000	26000	29000	42000	42000
User-side heat exchanger								
Quantity		n°	1	1	1	1	1	1
Water flow rate CH	(1)	m³/h	5.8	7.4	11	14.1	17.7	20.9
Pressure drop CH	(1)	kPa	17	18	22	24	24	25
Water flow rate HP	(1)	m³/h	6.1	7.5	11.3	14.4	17.9	21.4
Pressure drop HP	(1)	kPa	20	19	24	26	26	26
Noise levels								
Sound power level cooling	(4)	dB(A)	83	83	85	85	88	88
Sound pressure level cooling	(6)	dB(A)	51	51	53	53	56	56
Dimensions and weights**								
Length		mm	1750	1750	2539	3258	3258	3258
Depth		mm	1018	1018	1018	1153	1153	1153
Height		mm	1450	1450	1788	1788	2400	2400
Operating weight		kg	514	523	833	971	1052	1104

CH: chiller unit; HP: heat pump unit; MCHX: unit with microchannel coils

- (1) External air temperature of 35°C and user-side heat exchanger water inlet-outlet temperature of 12-7°C. Values compliant with standard EN 14511
- (2) Outside air temperature 7°C DB, 6°C WB; condenser inlet/outlet water temperature 40/45°C. Values compliant with standard EN 14511
- (3) Theoretical values referred to the basic unit. The amount of gas actually charged in the unit may differ.
- (4) Unit operating at rated capacity, with no accessories of any kind - external air temperature 35°C and water input/output temperature from/to heat exchanger and user equal to 12/7°C. Values taken by measurements made in accordance with standard ISO 3744 and the Eurovent certification programme, where applicable. Binding values See NOISE LEVELS section.
- (5) unit operating at nominal operating capacity, with no accessories of any kind, with external air temperature of 7°C (6°C WB) and user-side heat exchanger water inlet/outlet temperature of 40/45°C. Values obtained from measurements carried out in accordance with standard ISO 3744.
- (6) Values obtained from the sound power level (conditions: note 4), related to a distance of 10 m from the unit in free field with directivity factor Q=2. Non-binding values See NOISE LEVELS section.
- (7) Approximate value. The minimum capacity reached by the unit depends on the operating conditions. The value shown may not be suitable for calculating the minimum volume of water: to do this, consult the "Minimum water content in the system" section.

** Basic unit without included accessories

The certified standard performances and data can be verified in <https://www.eurovent-certification.com>

Some voluntary data are not certified (i.e. Noise Level for water source units; SCOP for units with Pdesign >70 KW; SCOP MT values).

ZETA SKY Hi HP R7 SLN [R32]

			3.1	4.1	6.2	8.2	10.2	12.2
Cooling								
Refrigeration capacity	(1)	kW	33.18	42.92	63.15	81.17	102.1	120.73
Total absorbed power	(1)	kW	11	14.49	21.1	26.11	31.87	39.96
EER	(1)		3.02	2.96	2.99	3.11	3.2	3.02
Heating								
Heating capacity	(1)	kW	35.38	43.88	65.68	83.58	104.07	124.78
Total absorbed power	(1)	kW	11.28	13.68	20.88	25.87	33.03	38.24
COP	(1)		3.14	3.21	3.15	3.23	3.15	3.26
Compressors								
Compressors/Circuits		n°	1/1	1/1	2/1	2/1	2/1	2/1
Minimum capacity reduction step	(7)	%	22	25	20	15	20	16
Refrigerant charge HP	(3)	kg	5	5.7	8.6	11.7	15	16
Fans								
Quantity		n°	2	2	3	3	2	2
Total air flow rate HP		m³/h	11900	12400	19800	22300	31300	31100
User-side heat exchanger								
Quantity		n°	1	1	1	1	1	1
Water flow rate CH	(1)	m³/h	5.7	7.4	10.9	14	17.6	20.8
Pressure drop CH	(1)	kPa	17	18	22	24	24	25
Water flow rate HP	(1)	m³/h	6.1	7.5	11.3	14.4	17.9	21.4
Pressure drop HP	(1)	kPa	20	19	24	26	26	26
Noise levels								
Sound power lev. SLN vers.	(4)	dB(A)	81	81	83	83	83	83
Sound pressure lev. SLN vers.	(6)	dB(A)	49	49	51	51	51	51
Dimensions and weights**								
Length		mm	1750	1750	2539	3258	3258	3258
Depth		mm	1018	1018	1018	1153	1153	1153
Height		mm	1450	1450	1788	1788	2400	2400
Operating weight		kg	514	523	833	971	1052	1104

CH: chiller unit; HP: heat pump unit; MCHX: unit with microchannel coils

- (1) External air temperature of 35°C and user-side heat exchanger water inlet-outlet temperature of 12-7°C. Values compliant with standard EN 14511
- (2) Outside air temperature 7°C DB, 6°C WB; condenser inlet/outlet water temperature 40/45°C. Values compliant with standard EN 14511
- (3) Theoretical values referred to the basic unit. The amount of gas actually charged in the unit may differ.
- (4) Unit operating at rated capacity, with no accessories of any kind - external air temperature 35°C and water input/output temperature from/to heat exchanger and user equal to 12/7°C. Values taken by measurements made in accordance with standard ISO 3744 and the Eurovent certification programme, where applicable. Binding values See NOISE LEVELS section.
- (5) unit operating at nominal operating capacity, with no accessories of any kind, with external air temperature of 7°C (6°C WB) and user-side heat exchanger water inlet/outlet temperature of 40/45°C. Values obtained from measurements carried out in accordance with standard ISO 3744.
- (6) Values obtained from the sound power level (conditions: note 4), related to a distance of 10 m from the unit in free field with directivity factor Q=2. Non-binding values See NOISE LEVELS section.
- (7) Approximate value. The minimum capacity reached by the unit depends on the operating conditions. The value shown may not be suitable for calculating the minimum volume of water: to do this, consult the "Minimum water content in the system" section.

** Basic unit without included accessories

The certified standard performances and data can be verified in <https://www.eurovent-certification.com>

Some voluntary data are not certified (i.e. Noise Level for water source units; SCOP for units with Pdesign >70 KW; SCOP MT values).

ECODESIGN

INTRODUCTION

The Ecodesign/ErP Directive (2009/125/EC) lays down new standards for more efficient energy use.

The Directive contains various regulations; as regards chiller products and heat pumps, the regulations of interest are the following:

- Regulation 2013/813, for small heat pumps ($P_{\text{design}} \leq 400$ kW)
- Regulation 2016/2281, for chillers and heat pumps with $P_{\text{design}} > 400$ kW
- Regulation 2013/811, for heat pumps with $P_{\text{design}} \leq 70$ kW.

The last-mentioned regulation (2013/811) regards the labelling (Ecolabel certification) of small heat pumps.

The other two regulations (2013/813 and 2016/2281) set seasonal efficiency targets that the products must comply with to be sold and installed in the European Union (essential requirement for CE marking).

These efficiency limits are defined through ratios, which are respectively:

- η_{sh} (SCOP), with reference to regulation 2013/813
- η_{sc} (SEER) for comfort applications and SEPR for process applications, with reference to regulation 2016/2281.

As regards regulation 2016/2281, with effect from 1st January 2021, the required minimum efficiency limit will be raised (Tier 2) from the current threshold (Tier 1).

The figure below schematically illustrates the correspondence between product and reference energy ratio.

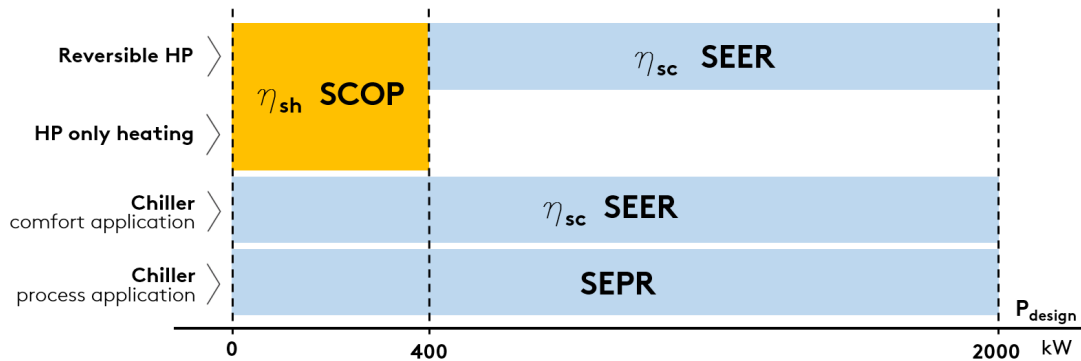

Some notes and clarifications:

For comfort applications, regulation 2016/2281 sets the η_{sc} (SEER) ratio in two different operating conditions:

- SEER calculated with machine inlet/outlet water temperature of 12/7°C (low temperature application),
- SEER calculated with machine inlet/outlet water temperature of 23/18°C (medium temperature application).

The minimum efficiency requirement is the same, but can be met at condition 12/7°C or at condition 23/18°C, depending on the application envisaged for the machine.

Regulation 2013/813 distinguishes two different types: at low temperature and at medium temperature.

The following refer to the application at low temperature: (low temperature application) all heat pumps whose maximum delivery temperature for heating purposes is lower than 52°C with source at temperature of -7°C and -8°C wet bulb (air-water unit) or inlet 10°C (water-water unit), at the reference design conditions for an average climate. For these, the efficiency ratio is "low temperature application" (outlet water temperature 35°C).

For all the other heat pumps, the efficiency ratio is related to "medium temperature application" (outlet water temperature 55°C).

The ratios must be calculated according to the reference European heating season in average climatic conditions.

The minimum efficiency requirements set by the regulations are indicated below.

REGULATION 2016/2281, comfort application

TYPE OF UNIT		MINIMUM REQUIREMENT	
SOURCE	P _{design}	η_{sc} [%]	SEER
air	< 400 kW	161	4,1
air	\geq 400 kW	179	4,55
water	< 400 kW	200	5,075
water	\geq 400 kW and < 1500 kW	252	6,375
water	\geq 1500 kW	272	6,875

REGULATION 2016/2281, process application

TYPE OF UNIT		MINIMUM REQUIREMENT
SOURCE	P _{design}	SEPR
air	< 400 kW	5
air	\geq 400 kW	5,5
water	< 400 kW	7
water	\geq 400 kW and < 1500 kW	8
water	\geq 1500 kW	8,5

REGULATION 2013/813

SOURCE	APPLICATION	MINIMUM REQUIREMENT	
		η_{sh} [%]	SCOP
air	low temperature application	125	3,2
water	low temperature application	125	3,325
air	medium temperature application	110	2,825
water	medium temperature application	110	2,95

The conformity of the product must be checked according to the type of application, whether comfort or process, and at the required outlet water temperature.

The two schematic tables below, respectively for comfort application and for process application, indicate the reference of the required conformity according to the type of product and the set point temperature (reference to regulations 2016/2281 and 2013/813).

Important note: for mixed comfort and process applications, the reference application for conformity is the comfort application.

COMFORT APPLICATION

PRODUCT	OUTLET WATER TEMPERATURE	COMPLIANCE INDEX	REGULATION
Chiller	< 18°C	SEER/η _{sc} low temperature application	2016/2281
	≥ 18°C	SEER/η _{sc} medium temperature application	2016/2281
Heat pumps (reversible and only heating) P_{design} ≤ 400kW		SCOP/η _{sh}	2013/813
Reversible heat pumps P_{design} > 400kW	< 18°C	SEER/η _{sc} low temperature application	2016/2281
	≥ 18°C	SEER/η _{sc} medium temperature application	2016/2281
Heat pumps only heating P_{design} > 400kW		-	-

- = exemption from Ecodesign

PROCESS APPLICATION

PRODUCT	OUTLET WATER TEMPERATURE	COMPLIANCE INDEX	REGULATION
Chiller	≥ +2°C , ≤ 12°C	SEPR	2016/2281
	> 12°C	-	-
	> -8°C , < +2°C	-	-

- = exemption from Ecodesign

Some specifications and notes follow.

EC fans:

The only option that positively affects the performance of the unit, by increasing its seasonal energy efficiency ratio, is the VEC accessory.

A unit equipped with EC fans has a higher SEER (η_{sc}) than the configuration with standard fans.

GAMMA ZETA SKY

With specific reference to the Zeta SKY range, below is a list of relevant regulations relating to the different units in their various configurations.

- chiller version: regulation 2016/2281
- HP version: regulation 2013/813 (since they are all units with $P_{\text{design}} \leq 400$ kW).

The tables below give information on the conformity of the units and the seasonal energy performance ratios with regard to the reference regulation.

ZETA SKY R7 [R32]

			3.2	4.2	5.2	6.2	7.2	8.2
REGULATION 2016-2281								
Pdesign	(1)	kW	-	-	-	-	-	-
COMFORT								
Standard Unit								
ηsc	(1)	%	167.4	162.6	165.8	165	170.2	171
SEER	(1)		4.26	4.14	4.22	4.2	4.33	4.35
Compliance Tier 2 (2021)	(1)		Y	Y	Y	Y	Y	Y
Unit with EC fans (VEC)								
ηsc	(1)	%	172.2	167	169.8	168.6	174.2	175.8
SEER	(1)		4.38	4.25	4.32	4.29	4.43	4.47
Compliance Tier 2 (2021)	(1)		Y	Y	Y	Y	Y	Y
PROCESS								
SEPR	(2)		5.78	5.55	5.59	5.92	6.14	6.01
Compliance Tier 2 (2021)	(2)		Y	Y	Y	Y	Y	Y

			9.2	10.2	12.2	13.2	15.2	17.2
REGULATION 2016-2281								
Pdesign	(1)	kW	-	-	-	-	-	-
COMFORT								
Standard Unit								
ηsc	(1)	%	173.4	172.6	171.8	171	175.8	176.2
SEER	(1)		4.41	4.39	4.37	4.35	4.47	4.48
Compliance Tier 2 (2021)	(1)		Y	Y	Y	Y	Y	Y
Unit with EC fans (VEC)								
ηsc	(1)	%	180.2	176.6	175	176.2	181	179
SEER	(1)		4.58	4.49	4.45	4.48	4.6	4.55
Compliance Tier 2 (2021)	(1)		Y	Y	Y	Y	Y	Y
PROCESS								
SEPR	(2)		5.79	5.63	5.53	5.65	5.88	5.82
Compliance Tier 2 (2021)	(2)		Y	Y	Y	Y	Y	Y

			14.4	16.4	18.4	20.4	24.4	
REGULATION 2016-2281								
Pdesign	(1)	kW	-	-	-	-	-	
COMFORT								
Standard Unit								
ηsc	(1)	%	173.4	169.4	174.2	168.2	168.2	
SEER	(1)		4.41	4.31	4.43	4.28	4.28	
Compliance Tier 2 (2021)	(1)		Y	Y	Y	Y	Y	
Unit with EC fans (VEC)								
ηsc	(1)	%	181.8	175	181.4	173.4	171	
SEER	(1)		4.62	4.45	4.61	4.41	4.35	
Compliance Tier 2 (2021)	(1)		Y	Y	Y	Y	Y	
PROCESS								
SEPR	(2)		6.14	5.84	5.53	5.53	5.22	
Compliance Tier 2 (2021)	(2)		Y	Y	Y	Y	Y	

Y = unit in compliance with Ecodesign at the indicated condition. N = unit not in compliance with Ecodesign at the indicated condition: it can be installed only in non-EU countries.

- (1) User-side heat exchanger water inlet/outlet temperature 12/7°C (low temperature application), with reference to regulation 2016/2281 and standard EN 14825.
- (2) User-side heat exchanger water inlet/outlet temperature 12/7°C, with reference to regulation 2016/2281 and norm EN 14825.

The certified standard performances and data can be verified in <https://www.eurovent-certification.com>

Some voluntary data are not certified (i.e. Noise Level for water source units; SCOP for units with Pdesign >70 KW; SCOP MT values).

ZETA SKY SLN R7 [R32]

			3.2	4.2	5.2	6.2	7.2	8.2
REGULATION 2016-2281								
Pdesign	(1)	kW	-	-	-	-	-	-
COMFORT								
Standard Unit								
η_{sc}	(1)	%	164.2	161	163.8	161.4	168.6	167.8
SEER	(1)		4.18	4.1	4.17	4.11	4.29	4.27
Compliance Tier 2 (2021)	(1)		Y	Y	Y	Y	Y	Y
Unit with EC fans (VEC)								
η_{sc}	(1)	%	168.6	165.4	166.2	165.4	172.2	173.8
SEER	(1)		4.29	4.21	4.23	4.21	4.38	4.42
Compliance Tier 2 (2021)	(1)		Y	Y	Y	Y	Y	Y
PROCESS								
SEPR	(2)		5.64	5.46	5.48	5.68	5.9	5.73
Compliance Tier 2 (2021)	(2)		Y	Y	Y	Y	Y	Y

			9.2	10.2	12.2	13.2	15.2	17.2
REGULATION 2016-2281								
Pdesign	(1)	kW	-	-	-	-	-	-
COMFORT								
Standard Unit								
η_{sc}	(1)	%	170.2	171	168.6	167.8	172.6	173
SEER	(1)		4.33	4.35	4.29	4.27	4.39	4.4
Compliance Tier 2 (2021)	(1)		Y	Y	Y	Y	Y	Y
Unit with EC fans (VEC)								
η_{sc}	(1)	%	176.6	175	171.8	173	177.4	177.4
SEER	(1)		4.49	4.45	4.37	4.4	4.51	4.51
Compliance Tier 2 (2021)	(1)		Y	Y	Y	Y	Y	Y
PROCESS								
SEPR	(2)		5.58	5.56	5.43	5.59	5.73	5.6
Compliance Tier 2 (2021)	(2)		Y	Y	Y	Y	Y	Y

			14.4	16.4	18.4	20.4	24.4	
REGULATION 2016-2281								
Pdesign	(1)	kW	-	-	-	-	-	
COMFORT								
Standard Unit								
η_{sc}	(1)	%	171.8	167.8	172.6	166.6	166.6	
SEER	(1)		4.37	4.27	4.39	4.24	4.24	
Compliance Tier 2 (2021)	(1)		Y	Y	Y	Y	Y	
Unit with EC fans (VEC)								
η_{sc}	(1)	%	178.2	173.4	177.8	171.8	169.4	
SEER	(1)		4.53	4.41	4.52	4.37	4.31	
Compliance Tier 2 (2021)	(1)		Y	Y	Y	Y	Y	
PROCESS								
SEPR	(2)		6.08	5.65	5.51	5.4	5.2	
Compliance Tier 2 (2021)	(2)		Y	Y	Y	Y	Y	

Y = unit in compliance with Ecodesign at the indicated condition. N = unit not in compliance with Ecodesign at the indicated condition: it can be installed only in non-EU countries.

- (1) User-side heat exchanger water inlet/outlet temperature 12/7°C (low temperature application), with reference to regulation 2016/2281 and standard EN 14825.
- (2) User-side heat exchanger water inlet/outlet temperature 12/7°C, with reference to regulation 2016/2281 and norm EN 14825.

The certified standard performances and data can be verified in <https://www.eurovent-certification.com>

Some voluntary data are not certified (i.e. Noise Level for water source units; SCOP for units with Pdesign >70 KW; SCOP MT values).

ZETA SKY HP R7 [R32]

			3.2	4.2	5.2	6.2	7.2	8.2
REGULATION 2013/813			-					
Pdesign	(1)	kW	-					
COMFORT								
Standard Unit								
ηsh	(1)	%	143.8	141	145.4	143.4	143	
SCOP	(1)		3.67	3.6	3.71	3.66	3.65	
Unit with EC fans (VEC)								
ηsh	(1)	%	150.2	141.4	149		146.6	147.4
SCOP	(1)		3.83	3.61	3.8		3.74	3.76
REGULATION 2013/811			-					
Standard Unit								
Ecolabel	(2)		A+				-	
Unit with EC fans (VEC)								
Ecolabel	(2)		A++	A+			-	
			9.2	10.2	12.2	13.2	15.2	17.2
REGULATION 2013/813			-					
Pdesign	(1)	kW	-					
COMFORT								
Standard Unit								
ηsh	(1)	%	145	149	144.2	147.4	152.2	150.2
SCOP	(1)		3.7	3.8	3.68	3.76	3.88	3.83
Unit with EC fans (VEC)								
ηsh	(1)	%	146.6	152.2	147.4	151	156.2	153.4
SCOP	(1)		3.74	3.88	3.76	3.85	3.98	3.91
REGULATION 2013/811			-					
Standard Unit								
Ecolabel	(2)		-					
Unit with EC fans (VEC)								
Ecolabel	(2)		-					
			14.4	16.4	18.4	20.4	24.4	
REGULATION 2013/813			-					
Pdesign	(1)	kW	-					
COMFORT								
Standard Unit								
ηsh	(1)	%	145.4	143.4	146.6	144.2	147.8	
SCOP	(1)		3.71	3.66	3.74	3.68	3.77	
Unit with EC fans (VEC)								
ηsh	(1)	%	150.6	147	150.2	149	153.8	
SCOP	(1)		3.84	3.75	3.83	3.8	3.92	
REGULATION 2013/811			-					
Standard Unit								
Ecolabel	(2)		-					
Unit with EC fans (VEC)								
Ecolabel	(2)		-					

Y = unit in compliance with Ecodesign at the indicated condition. N = unit not in compliance with Ecodesign at the indicated condition: it can be installed only in non-EU countries.

- (1) User-side heat exchanger water inlet/outlet temperature 30/35°C, Average climate profile, with reference to regulation 2013/813 and norm EN 14825.
- (2) Energy efficiency class with reference to regulation 2013/811 (low temperature applications).

The certified standard performances and data can be verified in <https://www.eurovent-certification.com>

Some voluntary data are not certified (i.e. Noise Level for water source units; SCOP for units with Pdesign >70 KW; SCOP MT values).

ZETA SKY HP SLN R7 [R32]

			3.2	4.2	5.2	6.2	7.2	8.2
REGULATION 2013/813			-					
Pdesign	(1)	kW	-					
COMFORT								
Standard Unit								
ηsh	(1)	%	143.8	141	145.4	143.4	143	
SCOP	(1)		3.67	3.6	3.71	3.66	3.65	
Unit with EC fans (VEC)								
ηsh	(1)	%	150.2	141.4	149		146.6	147.4
SCOP	(1)		3.83	3.61	3.8		3.74	3.76
REGULATION 2013/811			-					
Standard Unit								
Ecolabel	(2)		A+				-	
Unit with EC fans (VEC)								
Ecolabel	(2)		A++	A+			-	
			9.2	10.2	12.2	13.2	15.2	17.2
REGULATION 2013/813			-					
Pdesign	(1)	kW	-					
COMFORT								
Standard Unit								
ηsh	(1)	%	145	149	144.2	147.4	152.2	150.2
SCOP	(1)		3.7	3.8	3.68	3.76	3.88	3.83
Unit with EC fans (VEC)								
ηsh	(1)	%	146.6	152.2	147.4	151	156.2	153.4
SCOP	(1)		3.74	3.88	3.76	3.85	3.98	3.91
REGULATION 2013/811			-					
Standard Unit								
Ecolabel	(2)		-					
Unit with EC fans (VEC)								
Ecolabel	(2)		-					
			14.4	16.4	18.4	20.4	24.4	
REGULATION 2013/813			-					
Pdesign	(1)	kW	-					
COMFORT								
Standard Unit								
ηsh	(1)	%	145.4	143.4	146.6	144.2	147.8	
SCOP	(1)		3.71	3.66	3.74	3.68	3.77	
Unit with EC fans (VEC)								
ηsh	(1)	%	150.6	147	150.2	149	153.8	
SCOP	(1)		3.84	3.75	3.83	3.8	3.92	
REGULATION 2013/811			-					
Standard Unit								
Ecolabel	(2)		-					
Unit with EC fans (VEC)								
Ecolabel	(2)		-					

Y = unit in compliance with Ecodesign at the indicated condition. N = unit not in compliance with Ecodesign at the indicated condition: it can be installed only in non-EU countries.

- (1) User-side heat exchanger water inlet/outlet temperature 30/35°C, Average climate profile, with reference to regulation 2013/813 and norm EN 14825.
- (2) Energy efficiency class with reference to regulation 2013/811 (low temperature applications).

The certified standard performances and data can be verified in <https://www.eurovent-certification.com>

Some voluntary data are not certified (i.e. Noise Level for water source units; SCOP for units with Pdesign >70 KW; SCOP MT values).

ZETA SKY HP R5 [R454B]

			3.2	4.2	5.2	6.2	7.2	8.2
REGULATION 2013/813			-					
Pdesign	(1)	kW	-					
COMFORT								
Standard Unit								
ηsh	(1)	%	138.6	134.6	135	136.2	140.6	139.4
SCOP	(1)		3.54	3.44	3.45	3.48	3.59	3.56
Unit with EC fans (VEC)								
ηsh	(1)	%	140.2	137.8	138.2	139	143.8	142.2
SCOP	(1)		3.58	3.52	3.53	3.55	3.67	3.63
REGULATION 2013/811			-					
Standard Unit								
Ecolabel	(2)		A+				-	
Unit with EC fans (VEC)								
Ecolabel	(2)		A+				-	
			9.2	10.2	12.2	13.2	15.2	17.2
REGULATION 2013/813			-					
Pdesign	(1)	kW	-					
COMFORT								
Standard Unit								
ηsh	(1)	%	144.6	142.6	136.6	139.8	145	135
SCOP	(1)		3.69	3.64	3.49	3.57	3.7	3.45
Unit with EC fans (VEC)								
ηsh	(1)	%	147.4	144.6	143		147.8	137
SCOP	(1)		3.76	3.69	3.65		3.77	3.5
REGULATION 2013/811			-					
Standard Unit								
Ecolabel	(2)		-					
Unit with EC fans (VEC)								
Ecolabel	(2)		-					
			14.4	16.4	18.4	20.4	24.4	
REGULATION 2013/813			-					
Pdesign	(1)	kW	-					
COMFORT								
Standard Unit								
ηsh	(1)	%	143.8	141.8	147	136.2	139.4	
SCOP	(1)		3.67	3.62	3.75	3.48	3.56	
Unit with EC fans (VEC)								
ηsh	(1)	%	147.4	148.2	149.8	140.2	143.4	
SCOP	(1)		3.76	3.78	3.82	3.58	3.66	
REGULATION 2013/811			-					
Standard Unit								
Ecolabel	(2)		-					
Unit with EC fans (VEC)								
Ecolabel	(2)		-					

Y = unit in compliance with Ecodesign at the indicated condition. N = unit not in compliance with Ecodesign at the indicated condition: it can be installed only in non-EU countries.

- (1) User-side heat exchanger water inlet/outlet temperature 30/35°C, Average climate profile, with reference to regulation 2013/813 and norm EN 14825.
- (2) Energy efficiency class with reference to regulation 2013/811 (low temperature applications).

The certified standard performances and data can be verified in <https://www.eurovent-certification.com>

Some voluntary data are not certified (i.e. Noise Level for water source units; SCOP for units with Pdesign >70 KW; SCOP MT values).

ZETA SKY HP SLN R5 [R454B]

				3.2	4.2	5.2	6.2	7.2	8.2
REGULATION 2013/813				-					
Pdesign	(1)	kw		-					
COMFORT									
Standard Unit									
ηsh	(1)	%		138.6	134.6	135	136.2	140.6	139.4
SCOP	(1)			3.54	3.44	3.45	3.48	3.59	3.56
Unit with EC fans (VEC)									
ηsh	(1)	%		140.2	137.8	138.2	139	143.8	142.2
SCOP	(1)			3.58	3.52	3.53	3.55	3.67	3.63
REGULATION 2013/811				-					
Standard Unit									
Ecolabel	(2)			A+				-	
Unit with EC fans (VEC)									
Ecolabel	(2)			A+				-	
				9.2	10.2	12.2	13.2	15.2	17.2
REGULATION 2013/813				-					
Pdesign	(1)	kw		-					
COMFORT									
Standard Unit									
ηsh	(1)	%		144.6	142.6	136.6	139.8	145	135
SCOP	(1)			3.69	3.64	3.49	3.57	3.7	3.45
Unit with EC fans (VEC)									
ηsh	(1)	%		147.4	144.6	143		147.8	137
SCOP	(1)			3.76	3.69	3.65		3.77	3.5
REGULATION 2013/811				-					
Standard Unit									
Ecolabel	(2)			-					
Unit with EC fans (VEC)									
Ecolabel	(2)			-					
				14.4	16.4	18.4	20.4	24.4	
REGULATION 2013/813				-					
Pdesign	(1)	kw		-					
COMFORT									
Standard Unit									
ηsh	(1)	%		143.8	141.8	147	136.2	139.4	
SCOP	(1)			3.67	3.62	3.75	3.48	3.56	
Unit with EC fans (VEC)									
ηsh	(1)	%		147.4	148.2	149.8	140.2	143.4	
SCOP	(1)			3.76	3.78	3.82	3.58	3.66	
REGULATION 2013/811				-					
Standard Unit									
Ecolabel	(2)			-					
Unit with EC fans (VEC)									
Ecolabel	(2)			-					

Y = unit in compliance with Ecodesign at the indicated condition. N = unit not in compliance with Ecodesign at the indicated condition: it can be installed only in non-EU countries.

- (1) User-side heat exchanger water inlet/outlet temperature 30/35°C, Average climate profile, with reference to regulation 2013/813 and norm EN 14825.
- (2) Energy efficiency class with reference to regulation 2013/811 (low temperature applications).

The certified standard performances and data can be verified in <https://www.eurovent-certification.com>

Some voluntary data are not certified (i.e. Noise Level for water source units; SCOP for units with Pdesign >70 KW; SCOP MT values).

ZETA SKY Hi R7 [R32]

			3.1	4.1	6.2	8.2	10.2	12.2
REGULATION 2016-2281								
Pdesign	(1)	kW	-	-	-	-	-	-
COMFORT								
Standard Unit								
η_{sc}	(1)	%	172.6	172.2	185	188.6	194.2	189.4
SEER	(1)		4.39	4.38	4.7	4.79	4.93	4.81
Compliance Tier 2 (2021)	(1)		Y	Y	Y	Y	Y	Y
Unit with EC fans (VEC)								
η_{sc}	(1)	%	185	181.4	193.4	197	205.8	197
SEER	(1)		4.7	4.61	4.91	5	5.22	5
Compliance Tier 2 (2021)	(1)		Y	Y	Y	Y	Y	Y
PROCESS								
SEPR	(2)		-	-	-	-	-	-
Compliance Tier 2 (2021)	(2)		Y	Y	Y	Y	Y	Y

Y = unit in compliance with Ecodesign at the indicated condition. N = unit not in compliance with Ecodesign at the indicated condition: it can be installed only in non-EU countries.

- (1) User-side heat exchanger water inlet/outlet temperature 12/7°C (low temperature application), with reference to regulation 2016/2281 and standard EN 14825.
- (2) User-side heat exchanger water inlet/outlet temperature 12/7°C, with reference to regulation 2016/2281 and norm EN 14825.

ZETA SKY Hi R7 SLN [R32]

			3.1	4.1	6.2	8.2	10.2	12.2
REGULATION 2016-2281								
Pdesign	(1)	kW	-	-	-	-	-	-
COMFORT								
Standard Unit								
η_{sc}	(1)	%	168.6	167.4	183	189	191.4	185.8
SEER	(1)		4.29	4.26	4.65	4.8	4.86	4.72
Compliance Tier 2 (2021)	(1)		Y	Y	Y	Y	Y	Y
Unit with EC fans (VEC)								
η_{sc}	(1)	%	182.6	179	191	195.4	201	193.4
SEER	(1)		4.64	4.55	4.85	4.96	5.1	4.91
Compliance Tier 2 (2021)	(1)		Y	Y	Y	Y	Y	Y
PROCESS								
SEPR	(2)		-	-	-	-	-	-
Compliance Tier 2 (2021)	(2)		Y	Y	Y	Y	Y	Y

Y = unit in compliance with Ecodesign at the indicated condition. N = unit not in compliance with Ecodesign at the indicated condition: it can be installed only in non-EU countries.

- (1) User-side heat exchanger water inlet/outlet temperature 12/7°C (low temperature application), with reference to regulation 2016/2281 and standard EN 14825.
- (2) User-side heat exchanger water inlet/outlet temperature 12/7°C, with reference to regulation 2016/2281 and norm EN 14825.

The certified standard performances and data can be verified in <https://www.eurovent-certification.com>

Some voluntary data are not certified (i.e. Noise Level for water source units; SCOP for units with Pdesign >70 KW; SCOP MT values).

ZETA SKY Hi HP R7 [R32]

			3.1	4.1	6.2	8.2	10.2	12.2
REGULATION 2013/813			-					
Pdesign	(1)	kW	29	35.8	54	68.3	85.5	99.8
COMFORT								
Standard Unit								
ηsh	(1)	%	144.6	147	149.4	150.2	155.8	152.6
SCOP	(1)		3.69	3.75	3.81	3.83	3.97	3.89
Unit with EC fans (VEC)								
ηsh	(1)	%	150.2	151.8	154.6	153	160.2	155.8
SCOP	(1)		3.83	3.87	3.94	3.9	4.08	3.97
REGULATION 2013/811			-					
Standard Unit								
Ecolabel	(2)		A+			-		
Unit with EC fans (VEC)								
Ecolabel	(2)		A++			-		

Y = unit in compliance with Ecodesign at the indicated condition. N = unit not in compliance with Ecodesign at the indicated condition: it can be installed only in non-EU countries.

- (1) User-side heat exchanger water inlet/outlet temperature 30/35°C, Average climate profile, with reference to regulation 2013/813 and norm EN 14825.
 (2) Energy efficiency class with reference to regulation 2013/811 (low temperature applications).

ZETA SKY Hi HP SLN R7 [R32]

			3.1	4.1	6.2	8.2	10.2	12.2
REGULATION 2013/813			-					
Pdesign	(1)	kW	-					
COMFORT								
Standard Unit								
ηsh	(1)	%	144.6	147	149.4	150.2	155.8	152.6
SCOP	(1)		3.69	3.75	3.81	3.83	3.97	3.89
Unit with EC fans (VEC)								
ηsh	(1)	%	150.2	151.8	154.6	153	160.2	155.8
SCOP	(1)		3.83	3.87	3.94	3.9	4.08	3.97
REGULATION 2013/811			-					
Standard Unit								
Ecolabel	(2)		A+			-		
Unit with EC fans (VEC)								
Ecolabel	(2)		A++			-		

Y = unit in compliance with Ecodesign at the indicated condition. N = unit not in compliance with Ecodesign at the indicated condition: it can be installed only in non-EU countries.

- (1) User-side heat exchanger water inlet/outlet temperature 30/35°C, Average climate profile, with reference to regulation 2013/813 and norm EN 14825.
 (2) Energy efficiency class with reference to regulation 2013/811 (low temperature applications).

The certified standard performances and data can be verified in <https://www.eurovent-certification.com>

Some voluntary data are not certified (i.e. Noise Level for water source units; SCOP for units with Pdesign >70 KW; SCOP MT values).

ELECTRICAL SPECIFICATIONS

ZETA SKY R7 [R32]

			3.2	4.2	5.2	6.2	7.2	8.2
General electrical specifications								
Max. absorbed current (FLA)	(1)	A	37,6	41,6	45,0	50,7	69,9	69,9
Nominal current (Inom)	(2)	A	25	28	30	36	48	52
cosφ standard unit	(2)		0.83	0.83	0.82	0.81	0.82	0.8
Nominal current with power factor correction (Inom)	(2)	A	21.5	24.2	25	30	41	46.6
cosφ unit with power factor correction	(2)		0.97	0.96	0.97	0.97	0.95	0.97
Maximum inrush current (MIC)	(3)	A	122	151	162	166	179	213
Maximum inrush current with soft-starter (MIC)	(4)	A	82	100	107	110	123	143
Power supply		V/ph/Hz	400/3~+N/50					
Power supply for auxiliary circuits		mm²	230-24/1~/50					
Suggested line section	(5)	mm²	4G10 mm2 FG16OR16	4G10 mm2 FG16OR16	4G10 mm2 FG16OR16	4G16 mm2 FG16OR16	3x25 + 1G16 mm2 FG16OR16	3x25 +1G16 mm2 FG16OR16
Suggested line protection	(6)		NH00gG 50A	NH00gG 50A	NH00gG 50A	NH00gG 63A	NH00gG 80A	NH00gG 80A
Electrical specifications for fans								
Rated power of standard fan	(1)	n° x kW	2 x 0,6	2 x 0,6	2 x 0,6	2 x 0,6	3 x 0,6	3 x 0,6
Rated current of standard fan	(1)	n° x A	2 x 2,6	2 x 2,6	2 x 2,6	2 x 2,6	3 x 2,6	3 x 2,6
Rated power of EC fan	(2)	n° x kW	2 x 0,8	2 x 0,8	2 x 0,8	2 x 0,8	3 x 0,8	3 x 0,8
Rated current of EC fan	(2)	n° x A	2 x 1,4	2 x 1,4	2 x 1,4	2 x 1,4	3 x 1,4	3 x 1,4
Rated power of oversize EC fan	(2)	n° x kW	2 x 1,0	2 x 1,0	2 x 1,0	2 x 1,0	3 x 1,0	3 x 1,0
Rated current of oversized EC fan	(2)	n° x A	2 x 1,6	2 x 1,6	2 x 1,6	2 x 1,6	3 x 1,6	3 x 1,6

			9.2	10.2	12.2	13.2	15.2	17.2
General electrical specifications								
Max. absorbed current (FLA)	(1)	A	76,0	83,2	93,6	107,4	124,2	141,4
Nominal current (Inom)	(2)	A	60	63	70	80.6	88	99
cosφ standard unit	(2)		0.77	0.8	0.8	0.8	0.83	0.83
Nominal current with power factor correction (Inom)	(2)	A	48	51	57	67	76	87
cosφ unit with power factor correction	(2)		0.96	0.98	0.97	0.96	0.96	0.95
Maximum inrush current (MIC)	(3)	A	279	286	333	346	369	467
Maximum inrush current with soft-starter (MIC)	(4)	A	182	189	218	231	245	304
Power supply		V/ph/Hz	400/3~/50					
Power supply for auxiliary circuits		mm²	230-24/1~/50					
Suggested line section	(5)	mm²	3x25 + 1G16 mm2 FG16OR16	3x25 + 1G16 mm2 FG16OR16	3x35 + 1G25 mm2 FG16OR16	3x35 + 1G25 mm2 FG16OR16	3x50 + 1G25 mm2 FG16OR16	3x70 + 1G35 mm2 FG16OR16
Suggested line protection	(6)		NH00gG 100A	NH00gG 100A	NH00gG 125A	NH00gG 125A	NH00gG 160A	NH1gG 200A
Electrical specifications for fans								
Rated power of standard fan	(1)	n° x kW	2 x 1,5	2 x 1,5	2 x 1,5	3 x 1,5	3 x 1,5	3 x 1,5
Rated current of standard fan	(1)	n° x A	2 x 3,4	2 x 3,4	2 x 3,4	3 x 3,4	3 x 3,4	3 x 3,4
Rated power of EC fan	(2)	n° x kW	2 x 1,3	2 x 1,3	2 x 1,3	3 x 1,3	3 x 1,3	3 x 1,3
Rated current of EC fan	(2)	n° x A	2 x 1,9	2 x 1,9	2 x 1,9	3 x 1,9	3 x 1,9	3 x 1,9
Rated power of oversize EC fan	(2)	n° x kW	2 x 2,9	2 x 2,9	2 x 2,9	3 x 2,9	3 x 2,9	3 x 2,9
Rated current of oversized EC fan	(2)	n° x A	2 x 4,4	2 x 4,4	2 x 4,4	3 x 4,4	3 x 4,4	3 x 4,4

- (1) Data regarding the unit without accessories working in maximum power absorption conditions
- (2) Datum related to the unit without accessories working in standard conditions (A35°C; W12-7°C)
- (3) Maximum effective RMS value of the current when the last compressor starts (FLA of the entire unit - FLA of the largest compressor + LRA of the largest compressor)
- (4) Maximum effective RMS value of the current when the last compressor starts (FLA of the entire unit - FLA of the largest compressor + 0.6 x LRA of the largest compressor)
- (5) These values are determined for cables with operating temperature of 40°C, EPR insulation and a line with a maximum length of 50m. The line section must be determined by a qualified technician based on the protection devices, the length of the line, the type of cable used and the type of installation.
- (6) The correct line protection part must be determined by a qualified technician based on the length of the line, the type of cable used and the type of installation.

ZETA SKY R7 [R32]

			14.4	16.4	18.4	20.4	24.4
General electrical specifications							
Max. absorbed current (FLA)	(1)	A	120,0	134,2	148,6	155,8	183,8
Nominal current (Inom)	(2)	A	89	110	112	119	136
cosφ standard unit	(2)		0.76	0.74	0.78	0.79	0.8
Nominal current with power factor correction (Inom)	(2)	A	69	83	91	98	111
cosφ unit with power factor correction	(2)		0.98	0.98	0.98	0.95	0.98
Maximum inrush current (MIC)	(3)	A	229	277	351	358	423
Maximum inrush current with soft-starter (MIC)	(4)	A	173	208	255	262	308
Power supply		V/ph/Hz	400/3~/50				
Power supply for auxiliary circuits		mm ²	230-24/1~/50				
Suggested line section	(5)	mm ²	3x50 + 1G25 mm2 FG16OR16	3x50 + 1G25 mm2 FG16OR16	3x70 + 1G35 mm2 FG16OR16	3x70 + 1G35 mm2 FG16OR16	3x95 + 1G50 mm2 FG16OR16
Suggested line protection	(6)		NH00gG 160A	NH00gG 160A	NH1gG 200A	NH1gG 200A	NH1gG 250A
Electrical specifications for fans							
Rated power of standard fan	(1)	n° x kW	3 x 1,5	3 x 1,5	3 x 1,5	3 x 1,5	3 x 1,5
Rated current of standard fan	(1)	n° x A	3 x 3,4	3 x 3,4	3 x 3,4	3 x 3,4	3 x 3,4
Rated power of EC fan	(2)	n° x kW	3 x 1,3	3 x 1,3	3 x 1,3	3 x 1,3	3 x 1,3
Rated current of EC fan	(2)	n° x A	3 x 1,9	3 x 1,9	3 x 1,9	3 x 1,9	3 x 1,9
Rated power of oversize EC fan	(2)	n° x kW	3 x 2,9	3 x 2,9	3 x 2,9	3 x 2,9	3 x 2,9
Rated current of oversized EC fan	(2)	n° x A	3 x 4,4	3 x 4,4	3 x 4,4	3 x 4,4	3 x 4,4

- (1) Data regarding the unit without accessories working in maximum power absorption conditions
- (2) Datum related to the unit without accessories working in standard conditions (A35°C; W12-7°C)
- (3) Maximum effective RMS value of the current when the last compressor starts (FLA of the entire unit - FLA of the largest compressor + LRA of the largest compressor)
- (4) Maximum effective RMS value of the current when the last compressor starts (FLA of the entire unit - FLA of the largest compressor + 0.6 x LRA of the largest compressor)
- (5) These values are determined for cables with operating temperature of 40°C, EPR insulation and a line with a maximum length of 50m. The line section must be determined by a qualified technician based on the protection devices, the length of the line, the type of cable used and the type of installation.
- (6) The correct line protection part must be determined by a qualified technician based on the length of the line, the type of cable used and the type of installation.

ZETA SKY SLN R7 [R32]

			3.2	4.2	5.2	6.2	7.2	8.2
General electrical specifications								
Max. absorbed current	(1)	A	37,6	41,6	45,0	50,7	69,9	69,9
Nominal current (Inom)	(2)	A	25	28	30	36	48	52
cosφ standard unit	(2)		0.83	0.83	0.82	0.81	0.82	0.8
Nominal current with power factor correction (Inom)	(2)	A	21.5	24.2	25	30	41	46.6
cosφ unit with power factor correction	(2)		0.97	0.96	0.97	0.97	0.95	0.97
Maximum inrush current (MIC)	(3)	A	122	151	162	166	179	213
Maximum inrush current with soft-starter (MIC)	(4)	A	82	100	107	110	123	143
Power supply		V/ph/Hz	400/3~+N/50					
Power supply for auxiliary circuits		mm²	230-24/1~/50					
Suggested line section	(5)	mm²	4G10 mm2 FG16OR16	4G10 mm2 FG16OR16	4G10 mm2 FG16OR16	4G16 mm2 FG16OR16	3x25 + 1G16 mm2 FG16OR16	3x25 +1G16 mm2 FG16OR16
Suggested line protection	(6)		NH00gG 50A	NH00gG 50A	NH00gG 50A	NH00gG 63A	NH00gG 80A	NH00gG 80A
Electrical specifications for fans								
Rated power of standard fan	(1)	n° x kW	2 x 0,6	2 x 0,6	2 x 0,6	2 x 0,6	3 x 0,6	3 x 0,6
Rated current of standard fan	(1)	n° x A	2 x 2,6	2 x 2,6	2 x 2,6	2 x 2,6	3 x 2,6	3 x 2,6
Rated power of EC fan	(2)	n° x kW	2 x 0,8	2 x 0,8	2 x 0,8	2 x 0,8	3 x 0,8	3 x 0,8
Rated current of EC fan	(2)	n° x A	2 x 1,4	2 x 1,4	2 x 1,4	2 x 1,4	3 x 1,4	3 x 1,4
Rated power of oversize EC fan	(2)	n° x kW	2 x 1,0	2 x 1,0	2 x 1,0	2 x 1,0	3 x 1,0	3 x 1,0
Rated current of oversized EC fan	(2)	n° x A	2 x 1,6	2 x 1,6	2 x 1,6	2 x 1,6	3 x 1,6	3 x 1,6

			9.2	10.2	12.2	13.2	15.2	17.2
General electrical specifications								
Max. absorbed current (FLA)	(1)	A	76,0	83,2	93,6	107,4	124,2	141,4
Nominal current (Inom)	(2)	A	60	63	70	80.6	88	99
cosφ standard unit	(2)		0.77	0.8	0.8	0.8	0.83	0.83
Nominal current with power factor correction (Inom)	(2)	A	48	51	57	67	76	87
cosφ unit with power factor correction	(2)		0.96	0.98	0.97	0.96	0.96	0.95
Maximum inrush current (MIC)	(3)	A	279	286	333	346	369	467
Maximum inrush current with soft-starter (MIC)	(4)	A	182	189	218	231	245	304
Power supply		V/ph/Hz	400/3~/50					
Power supply for auxiliary circuits		mm²	230-24/1~/50					
Suggested line section	(5)	mm²	3x25 + 1G16 mm2 FG16OR16	3x25 + 1G16 mm2 FG16OR16	3x35 + 1G25 mm2 FG16OR16	3x35 + 1G25 mm2 FG16OR16	3x50 + 1G25 mm2 FG16OR16	3x70 + 1G35 mm2 FG16OR16
Suggested line protection	(6)		NH00gG 100A	NH00gG 100A	NH00gG 125A	NH00gG 125A	NH00gG 160A	NH1gG 200A
Electrical specifications for fans								
Rated power of standard fan	(1)	n° x kW	2 x 1,5	2 x 1,5	2 x 1,5	3 x 1,5	3 x 1,5	3 x 1,5
Rated current of standard fan	(1)	n° x A	2 x 3,4	2 x 3,4	2 x 3,4	3 x 3,4	3 x 3,4	3 x 3,4
Rated power of EC fan	(2)	n° x kW	2 x 1,3	2 x 1,3	2 x 1,3	3 x 1,3	3 x 1,3	3 x 1,3
Rated current of EC fan	(2)	n° x A	2 x 1,9	2 x 1,9	2 x 1,9	3 x 1,9	3 x 1,9	3 x 1,9
Rated power of oversize EC fan	(2)	n° x kW	2 x 2,9	2 x 2,9	2 x 2,9	3 x 2,9	3 x 2,9	3 x 2,9
Rated current of oversized EC fan	(2)	n° x A	2 x 4,4	2 x 4,4	2 x 4,4	3 x 4,4	3 x 4,4	3 x 4,4

- (1) Data regarding the unit without accessories working in maximum power absorption conditions
- (2) Datum related to the unit without accessories working in standard conditions (A35°C; W12-7°C)
- (3) Maximum effective RMS value of the current when the last compressor starts (FLA of the entire unit - FLA of the largest compressor + LRA of the largest compressor)
- (4) Maximum effective RMS value of the current when the last compressor starts (FLA of the entire unit - FLA of the largest compressor + 0.6 x LRA of the largest compressor)
- (5) These values are determined for cables with operating temperature of 40°C, EPR insulation and a line with a maximum length of 50m. The line section must be determined by a qualified technician based on the protection devices, the length of the line, the type of cable used and the type of installation.
- (6) The correct line protection part must be determined by a qualified technician based on the length of the line, the type of cable used and the type of installation.

ZETA SKY SLN R7 [R32]

			14.4	16.4	18.4	20.4	24.4
General electrical specifications							
Max. absorbed current	(1)	A	122,7	136,9	151,3	158,5	186,5
Nominal current (Inom)	(2)	A	89	110	112	119	136
cosφ standard unit	(2)		0.76	0.74	0.78	0.79	0.8
Nominal current with power factor correction (Inom)	(2)	A	69	83	91	98	111
cosφ unit with power factor correction	(2)		0.98	0.98	0.98	0.95	0.98
Maximum inrush current (MIC)	(3)	A	232	280	354	361	425
Maximum inrush current with soft-starter (MIC)	(4)	A	176	210	258	265	310
Power supply		V/ph/Hz	400/3~/50				
Power supply for auxiliary circuits		mm ²	230-24/1~/50				
Suggested line section	(5)	mm ²	3x50 + 1G25 mm2 FG16OR16	3x50 + 1G25 mm2 FG16OR16	3x70 + 1G35 mm2 FG16OR16	3x70 + 1G35 mm2 FG16OR16	3x95 + 1G50 mm2 FG16OR16
Suggested line protection	(6)		NH00gG 160A	NH00gG 160A	NH1gG 200A	NH1gG 200A	NH1gG 250A
Electrical specifications for fans							
Rated power of standard fan	(1)	n° x kW	3 x 2,0	3 x 2,0	3 x 2,0	3 x 2,0	3 x 2,0
Rated current of standard fan	(1)	n° x A	3 x 4,3	3 x 4,3	3 x 4,3	3 x 4,3	3 x 4,3
Rated power of EC fan	(2)	n° x kW	3 x 1,9	3 x 1,9	3 x 1,9	3 x 1,9	3 x 1,9
Rated current of EC fan	(2)	n° x A	3 x 2,9	3 x 2,9	3 x 2,9	3 x 2,9	3 x 2,9
Rated power of oversize EC fan	(2)	n° x kW	3 x 3,0	3 x 3,0	3 x 3,0	3 x 3,0	3 x 3,0
Rated current of oversized EC fan	(2)	n° x A	3 x 4,5	3 x 4,5	3 x 4,5	3 x 4,5	3 x 4,5

(1) Data regarding the unit without accessories working in maximum power absorption conditions

(2) Datum related to the unit without accessories working in standard conditions (A35°C; W12-7°C)

(3) Maximum effective RMS value of the current when the last compressor starts (FLA of the entire unit - FLA of the largest compressor + LRA of the largest compressor)

(4) Maximum effective RMS value of the current when the last compressor starts (FLA of the entire unit - FLA of the largest compressor + 0.6 x LRA of the largest compressor)

(5) These values are determined for cables with operating temperature of 40°C, EPR insulation and a line with a maximum length of 50m. The line section must be determined by a qualified technician based on the protection devices, the length of the line, the type of cable used and the type of installation.

(6) The correct line protection part must be determined by a qualified technician based on the length of the line, the type of cable used and the type of installation.

ZETA SKY HP R7 [R32]

			3.2	4.2	5.2	6.2	7.2	8.2
General electrical specifications								
Max. absorbed current (FLA)	(1)	A	37,6	41,6	45,0	50,7	69,9	69,9
Nominal current (Inom)	(2)	A	25	28	30	36	48	52
cosφ standard unit	(2)		0.83	0.83	0.82	0.81	0.82	0.8
Nominal current with power factor correction (Inom)	(2)	A	21.5	24.2	25	30	41	46.6
cosφ unit with power factor correction	(2)		0.97	0.96	0.97	0.97	0.95	0.97
Maximum inrush current (MIC)	(3)	A	122	151	162	166	179	213
Maximum inrush current with soft-starter (MIC)	(4)	A	82	100	107	110	123	143
Power supply		V/ph/Hz	400/3~+N/50					
Power supply for auxiliary circuits		mm²	230-24/1~/50					
Suggested line section	(5)	mm²	4G10 mm2 FG16OR16	4G10 mm2 FG16OR16	4G10 mm2 FG16OR16	4G16 mm2 FG16OR16	3x25 + 1G16 mm2 FG16OR16	3x25 +1G16 mm2 FG16OR16
Suggested line protection	(6)		NH00gG 50A	NH00gG 50A	NH00gG 50A	NH00gG 63A	NH00gG 80A	NH00gG 80A
Electrical specifications for fans								
Rated power of standard fan	(1)	n° x kW	2 x 0,6	2 x 0,6	2 x 0,6	2 x 0,6	3 x 0,6	3 x 0,6
Rated current of standard fan	(1)	n° x A	2 x 2,6	2 x 2,6	2 x 2,6	2 x 2,6	3 x 2,6	3 x 2,6
Rated power of EC fan	(2)	n° x kW	2 x 0,8	2 x 0,8	2 x 0,8	2 x 0,8	3 x 0,8	3 x 0,8
Rated current of EC fan	(2)	n° x A	2 x 1,4	2 x 1,4	2 x 1,4	2 x 1,4	3 x 1,4	3 x 1,4
Rated power of oversize EC fan	(2)	n° x kW	2 x 1,0	2 x 1,0	2 x 1,0	2 x 1,0	3 x 1,0	3 x 1,0
Rated current of oversized EC fan	(2)	n° x A	2 x 1,6	2 x 1,6	2 x 1,6	2 x 1,6	3 x 1,6	3 x 1,6
			9.2	10.2	12.2	13.2	15.2	17.2
General electrical specifications								
Max. absorbed current (FLA)	(1)	A	76,0	83,2	93,6	107,4	124,2	141,4
Nominal current (Inom)	(2)	A	60	63	70	80.6	88	99
cosφ standard unit	(2)		0.77	0.8	0.8	0.8	0.83	0.83
Nominal current with power factor correction (Inom)	(2)	A	48	51	57	67	76	87
cosφ unit with power factor correction	(2)		0.96	0.98	0.97	0.96	0.96	0.95
Maximum inrush current (MIC)	(3)	A	279	286	333	346	369	467
Maximum inrush current with soft-starter (MIC)	(4)	A	182	189	218	231	245	304
Power supply		V/ph/Hz	400/3~/50					
Power supply for auxiliary circuits		mm²	230-24/1~/50					
Suggested line section	(5)	mm²	3x25 + 1G16 mm2 FG16OR16	3x25 + 1G16 mm2 FG16OR16	3x35 + 1G25 mm2 FG16OR16	3x35 + 1G25 mm2 FG16OR16	3x50 + 1G25 mm2 FG16OR16	3x70 + 1G35 mm2 FG16OR16
Suggested line protection	(6)		NH00gG 100A	NH00gG 100A	NH00gG 125A	NH00gG 125A	NH00gG 160A	NH1gG 200A
Electrical specifications for fans								
Rated power of standard fan	(1)	n° x kW	2 x 1,5	2 x 1,5	2 x 1,5	3 x 1,5	3 x 1,5	3 x 1,5
Rated current of standard fan	(1)	n° x A	2 x 3,4	2 x 3,4	2 x 3,4	3 x 3,4	3 x 3,4	3 x 3,4
Rated power of EC fan	(2)	n° x kW	2 x 1,3	2 x 1,3	2 x 1,3	3 x 1,3	3 x 1,3	3 x 1,3
Rated current of EC fan	(2)	n° x A	2 x 1,9	2 x 1,9	2 x 1,9	3 x 1,9	3 x 1,9	3 x 1,9
Rated power of oversize EC fan	(2)	n° x kW	2 x 2,9	2 x 2,9	2 x 2,9	3 x 2,9	3 x 2,9	3 x 2,9
Rated current of oversized EC fan	(2)	n° x A	2 x 4,4	2 x 4,4	2 x 4,4	3 x 4,4	3 x 4,4	3 x 4,4

(1) Data regarding the unit without accessories working in maximum power absorption conditions

(2) Datum related to the unit without accessories working in standard conditions (A35°C; W12-7°C)

(3) Maximum effective RMS value of the current when the last compressor starts (FLA of the entire unit - FLA of the largest compressor + LRA of the largest compressor)

(4) Maximum effective RMS value of the current when the last compressor starts (FLA of the entire unit - FLA of the largest compressor + 0.6 x LRA of the largest compressor)

(5) These values are determined for cables with operating temperature of 40°C, EPR insulation and a line with a maximum length of 50m. The line section must be determined by a qualified technician based on the protection devices, the length of the line, the type of cable used and the type of installation.

(6) The correct line protection part must be determined by a qualified technician based on the length of the line, the type of cable used and the type of installation.

ZETA SKY HP R7 [R32]

			14.4	16.4	18.4	20.4	24.4
General electrical specifications							
Max. absorbed current (FLA)	(1)	A	120,0	134,2	148,6	155,8	183,8
Nominal current (Inom)	(2)	A	89	110	112	123	140
cosφ standard unit	(2)		0.76	0.74	0.78	0.78	0.8
Nominal current with power factor correction (Inom)	(2)	A	69	83	91	102	115
cosφ unit with power factor correction	(2)		0.98	0.98	0.98	0.95	0.96
Maximum inrush current (MIC)	(3)	A	229	277	351	358	423
Maximum inrush current with soft-starter (MIC)	(4)	A	173	208	255	262	308
Power supply		V/ph/Hz	400/3~/50				
Power supply for auxiliary circuits		mm ²	230-24/1~/50				
Suggested line section	(5)	mm ²	3x50 + 1G25 mm2 FG16OR16	3x50 + 1G25 mm2 FG16OR16	3x70 + 1G35 mm2 FG16OR16	3x70 + 1G35 mm2 FG16OR16	3x95 + 1G50 mm2 FG16OR16
Suggested line protection	(6)		NH00gG 160A	NH00gG 160A	NH1gG 200A	NH1gG 200A	NH1gG 250A
Electrical specifications for fans							
Rated power of standard fan	(1)	n° x kW	3 x 1,5	3 x 1,5	3 x 1,5	4 x 1,5	4 x 1,5
Rated current of standard fan	(1)	n° x A	3 x 3,4	3 x 3,4	3 x 3,4	4 x 3,4	4 x 3,4
Rated power of EC fan	(2)	n° x kW	3 x 1,3	3 x 1,3	3 x 1,3	4 x 1,3	4 x 1,3
Rated current of EC fan	(2)	n° x A	3 x 1,9	3 x 1,9	3 x 1,9	4 x 1,9	4 x 1,9
Rated power of oversize EC fan	(2)	n° x kW	3 x 2,9	3 x 2,9	3 x 2,9	4 x 2,9	4 x 2,9
Rated current of oversized EC fan	(2)	n° x A	3 x 4,4	3 x 4,4	3 x 4,4	4 x 4,4	4 x 4,4

- (1) Data regarding the unit without accessories working in maximum power absorption conditions
- (2) Datum related to the unit without accessories working in standard conditions (A35°C; W12-7°C)
- (3) Maximum effective RMS value of the current when the last compressor starts (FLA of the entire unit - FLA of the largest compressor + LRA of the largest compressor)
- (4) Maximum effective RMS value of the current when the last compressor starts (FLA of the entire unit - FLA of the largest compressor + 0.6 x LRA of the largest compressor)
- (5) These values are determined for cables with operating temperature of 40°C, EPR insulation and a line with a maximum length of 50m. The line section must be determined by a qualified technician based on the protection devices, the length of the line, the type of cable used and the type of installation.
- (6) The correct line protection part must be determined by a qualified technician based on the length of the line, the type of cable used and the type of installation.

ZETA SKY HP SLN R7 [R32]

			3.2	4.2	5.2	6.2	7.2	8.2
General electrical specifications								
Max. absorbed current (FLA)	(1)	A	37,6	41,6	45,0	50,7	69,9	69,9
Nominal current (Inom)	(2)	A	25	28	30	36	48	52
cosφ standard unit	(2)		0.83	0.83	0.82	0.81	0.82	0.8
Nominal current with power factor correction (Inom)	(2)	A	21.5	24.2	25	30	41	46.6
cosφ unit with power factor correction	(2)		0.97	0.96	0.97	0.97	0.95	0.97
Maximum inrush current (MIC)	(3)	A	122	151	162	166	179	213
Maximum inrush current with soft-starter (MIC)	(4)	A	82	100	107	110	123	143
Power supply		V/ph/Hz	400/3~+N/50					
Power supply for auxiliary circuits		mm²	230-24/1~/50					
Suggested line section	(5)	mm²	4G10 mm2 FG16OR16	4G10 mm2 FG16OR16	4G10 mm2 FG16OR16	4G16 mm2 FG16OR16	3x25 + 1G16 mm2 FG16OR16	3x25 +1G16 mm2 FG16OR16
Suggested line protection	(6)		NH00gG 50A	NH00gG 50A	NH00gG 50A	NH00gG 63A	NH00gG 80A	NH00gG 80A
Electrical specifications for fans								
Rated power of standard fan	(1)	n° x kW	2 x 0,6	2 x 0,6	2 x 0,6	2 x 0,6	3 x 0,6	3 x 0,6
Rated current of standard fan	(1)	n° x A	2 x 2,6	2 x 2,6	2 x 2,6	2 x 2,6	3 x 2,6	3 x 2,6
Rated power of EC fan	(2)	n° x kW	2 x 0,8	2 x 0,8	2 x 0,8	2 x 0,8	3 x 0,8	3 x 0,8
Rated current of EC fan	(2)	n° x A	2 x 1,4	2 x 1,4	2 x 1,4	2 x 1,4	3 x 1,4	3 x 1,4
Rated power of oversize EC fan	(2)	n° x kW	2 x 1,0	2 x 1,0	2 x 1,0	2 x 1,0	3 x 1,0	3 x 1,0
Rated current of oversized EC fan	(2)	n° x A	2 x 1,6	2 x 1,6	2 x 1,6	2 x 1,6	3 x 1,6	3 x 1,6

			9.2	10.2	12.2	13.2	15.2	17.2
General electrical specifications								
Max. absorbed current (FLA)	(1)	A	76,0	85,0	95,4	110,1	126,9	144,1
Nominal current (Inom)	(2)	A	60	63	70	80.6	88	99
cosφ standard unit	(2)		0.77	0.8	0.8	0.8	0.83	0.83
Nominal current with power factor correction (Inom)	(2)	A	48	51	57	67	76	87
cosφ unit with power factor correction	(2)		0.96	0.98	0.97	0.96	0.96	0.95
Maximum inrush current (MIC)	(3)	A	279	288	334	349	372	470
Maximum inrush current with soft-starter (MIC)	(4)	A	182	191	219	234	248	306
Power supply		V/ph/Hz	400/3~/50					
Power supply for auxiliary circuits		mm²	230-24/1~/50					
Suggested line section	(5)	mm²	3x25 + 1G16 mm2 FG16OR16	3x25 + 1G16 mm2 FG16OR16	3x35 + 1G25 mm2 FG16OR16	3x35 + 1G25 mm2 FG16OR16	3x50 + 1G25 mm2 FG16OR16	3x70 + 1G35 mm2 FG16OR16
Suggested line protection	(6)		NH00gG 100A	NH00gG 100A	NH00gG 125A	NH00gG 125A	NH00gG 160A	NH1gG 200A
Electrical specifications for fans								
Rated power of standard fan	(1)	n° x kW	2 x 1,5	2 x 1,5	2 x 1,5	3 x 1,5	3 x 1,5	3 x 1,5
Rated current of standard fan	(1)	n° x A	2 x 3,4	2 x 3,4	2 x 3,4	3 x 3,4	3 x 3,4	3 x 3,4
Rated power of EC fan	(2)	n° x kW	2 x 1,3	2 x 1,3	2 x 1,3	3 x 1,3	3 x 1,3	3 x 1,3
Rated current of EC fan	(2)	n° x A	2 x 1,9	2 x 1,9	2 x 1,9	3 x 1,9	3 x 1,9	3 x 1,9
Rated power of oversize EC fan	(2)	n° x kW	2 x 2,9	2 x 2,9	2 x 2,9	3 x 2,9	3 x 2,9	3 x 2,9
Rated current of oversized EC fan	(2)	n° x A	2 x 4,4	2 x 4,4	2 x 4,4	3 x 4,4	3 x 4,4	3 x 4,4

(1) Data regarding the unit without accessories working in maximum power absorption conditions

(2) Datum related to the unit without accessories working in standard conditions (A35°C; W12-7°C)

(3) Maximum effective RMS value of the current when the last compressor starts (FLA of the entire unit - FLA of the largest compressor + LRA of the largest compressor)

(4) Maximum effective RMS value of the current when the last compressor starts (FLA of the entire unit - FLA of the largest compressor + 0.6 x LRA of the largest compressor)

(5) These values are determined for cables with operating temperature of 40°C, EPR insulation and a line with a maximum length of 50m. The line section must be determined by a qualified technician based on the protection devices, the length of the line, the type of cable used and the type of installation.

(6) The correct line protection part must be determined by a qualified technician based on the length of the line, the type of cable used and the type of installation.

ZETA SKY HP SLN R7 [R32]

			14.4	16.4	18.4	20.4	24.4
General electrical specifications							
Max. absorbed current (FLA)	(1)	A	122,7	136,9	151,3	158,5	186,5
Nominal current (Inom)	(2)	A	89	110	112	123	140
cosφ standard unit	(2)		0.76	0.74	0.78	0.78	0.8
Nominal current with power factor correction (Inom)	(2)	A	69	83	91	102	115
cosφ unit with power factor correction	(2)		0.98	0.98	0.98	0.95	0.96
Maximum inrush current (MIC)	(3)	A	232	280	354	361	425
Maximum inrush current with soft-starter (MIC)	(4)	A	176	210	258	265	310
Power supply		V/ph/Hz	400/3~/50				
Power supply for auxiliary circuits		mm ²	230-24/1~/50				
Suggested line section	(5)	mm ²	3x50 + 1G25 mm2 FG16OR16	3x50 + 1G25 mm2 FG16OR16	3x70 + 1G35 mm2 FG16OR16	3x70 + 1G35 mm2 FG16OR16	3x95 + 1G50 mm2 FG16OR16
Suggested line protection	(6)		NH00gG 160A	NH00gG 160A	NH1gG 200A	NH1gG 200A	NH1gG 250A
Electrical specifications for fans							
Rated power of standard fan	(1)	n° x kW	3 x 1,5	3 x 1,5	3 x 1,5	4 x 1,5	4 x 1,5
Rated current of standard fan	(1)	n° x A	3 x 3,4	3 x 3,4	3 x 3,4	4 x 3,4	4 x 3,4
Rated power of EC fan	(2)	n° x kW	3 x 1,3	3 x 1,3	3 x 1,3	4 x 1,3	4 x 1,3
Rated current of EC fan	(2)	n° x A	3 x 1,9	3 x 1,9	3 x 1,9	4 x 1,9	4 x 1,9
Rated power of oversize EC fan	(2)	n° x kW	3 x 2,9	3 x 2,9	3 x 2,9	4 x 2,9	4 x 2,9
Rated current of oversized EC fan	(2)	n° x A	3 x 4,4	3 x 4,4	3 x 4,4	4 x 4,4	4 x 4,4

- (1) Data regarding the unit without accessories working in maximum power absorption conditions
- (2) Datum related to the unit without accessories working in standard conditions (A35°C; W12-7°C)
- (3) Maximum effective RMS value of the current when the last compressor starts (FLA of the entire unit - FLA of the largest compressor + LRA of the largest compressor)
- (4) Maximum effective RMS value of the current when the last compressor starts (FLA of the entire unit - FLA of the largest compressor + 0.6 x LRA of the largest compressor)
- (5) These values are determined for cables with operating temperature of 40°C, EPR insulation and a line with a maximum length of 50m. The line section must be determined by a qualified technician based on the protection devices, the length of the line, the type of cable used and the type of installation.
- (6) The correct line protection part must be determined by a qualified technician based on the length of the line, the type of cable used and the type of installation.

ZETA SKY HP R5 [R454B]

			3.2	4.2	5.2	6.2	7.2	8.2
General electrical specifications								
Max. absorbed current (FLA)	(1)	A	45,2	51,2	55,2	60,2	71,8	79,0
Nominal current (Inom)	(2)	A	28.6	33	34	37	45	51
cosφ standard unit	(2)		0.82	0.79	0.8	0.81	0.84	0.81
Nominal current with power factor correction (Inom)	(2)	A	25	27	28	31	39	42
cosφ unit with power factor correction	(2)		0.95	0.95	0.95	0.97	0.97	0.98
Maximum inrush current (MIC)	(3)	A	121	168	168	177	195	237
Maximum inrush current with soft-starter (MIC)	(4)	A	82	111	111	118	132	159
Power supply		V/ph/Hz	400/3~+N/50					
Power supply for auxiliary circuits		mm²	230-24/1~/50					
Suggested line section	(5)	mm²	4G10 mm2 FG16OR16	4G10 mm2 FG16OR16	4G10 mm2 FG16OR16	4G16 mm2 FG16OR16	3x25 + 1G16 mm2 FG16OR16	3x25 +1G16 mm2 FG16OR16
Suggested line protection	(6)		NH00gG 50A	NH00gG 50A	NH00gG 50A	NH00gG 63A	NH00gG 80A	NH00gG 80A
Electrical specifications for fans								
Rated power of standard fan	(1)	n° x kW	2 x 0,6	2 x 0,6	2 x 0,6	2 x 0,6	3 x 0,6	3 x 0,6
Rated current of standard fan	(1)	n° x A	2 x 2,6	2 x 2,6	2 x 2,6	2 x 2,6	3 x 2,6	3 x 2,6
Rated power of EC fan	(2)	n° x kW	2 x 0,8	2 x 0,8	2 x 0,8	2 x 0,8	3 x 0,8	3 x 0,8
Rated current of EC fan	(2)	n° x A	2 x 1,4	2 x 1,4	2 x 1,4	2 x 1,4	3 x 1,4	3 x 1,4
Rated power of oversize EC fan	(2)	n° x kW	2 x 1,0	2 x 1,0	2 x 1,0	2 x 1,0	3 x 1,0	3 x 1,0
Rated current of oversized EC fan	(2)	n° x A	2 x 1,6	2 x 1,6	2 x 1,6	2 x 1,6	3 x 1,6	3 x 1,6

			9.2	10.2	12.2	13.2	15.2	17.2
General electrical specifications								
Max. absorbed current (FLA)	(1)	A	92,5	104,9	126,9	128,4	145,4	189,4
Nominal current (Inom)	(2)	A	57	63	74	78	99	110
cosφ standard unit	(2)		0.79	0.81	0.82	0.81	0.81	0.8
Nominal current with power factor correction (Inom)	(2)	A	47	53	62	65	85	94
cosφ unit with power factor correction	(2)		0.96	0.96	0.98	0.97	0.95	0.95
Maximum inrush current (MIC)	(3)	A	257	269	325	326	386	427
Maximum inrush current with soft-starter (MIC)	(4)	A	171	183	221	222	258	290
Power supply		V/ph/Hz	400/3~/50					
Power supply for auxiliary circuits		mm²	230-24/1~/50					
Suggested line section	(5)	mm²	3x25 + 1G16 mm2 FG16OR16	3x25 + 1G16 mm2 FG16OR16	3x35 + 1G25 mm2 FG16OR16	3x35 + 1G25 mm2 FG16OR16	3x50 + 1G25 mm2 FG16OR16	3x70 + 1G35 mm2 FG16OR16
Suggested line protection	(6)		NH00gG 100A	NH00gG 100A	NH00gG 125A	NH00gG 125A	NH00gG 160A	NH1gG 200A
Electrical specifications for fans								
Rated power of standard fan	(1)	n° x kW	2 x 1,5	2 x 1,5	2 x 1,5	3 x 1,5	3 x 1,5	3 x 1,5
Rated current of standard fan	(1)	n° x A	2 x 3,4	2 x 3,4	2 x 3,4	3 x 3,4	3 x 3,4	3 x 3,4
Rated power of EC fan	(2)	n° x kW	2 x 1,3	2 x 1,3	2 x 1,3	3 x 1,3	3 x 1,3	3 x 1,3
Rated current of EC fan	(2)	n° x A	2 x 1,9	2 x 1,9	2 x 1,9	3 x 1,9	3 x 1,9	3 x 1,9
Rated power of oversize EC fan	(2)	n° x kW	2 x 2,9	2 x 2,9	2 x 2,9	3 x 2,9	3 x 2,9	3 x 2,9
Rated current of oversized EC fan	(2)	n° x A	2 x 4,4	2 x 4,4	2 x 4,4	3 x 4,4	3 x 4,4	3 x 4,4

- (1) Data regarding the unit without accessories working in maximum power absorption conditions
- (2) Datum related to the unit without accessories working in standard conditions (A35°C; W12-7°C)
- (3) Maximum effective RMS value of the current when the last compressor starts (FLA of the entire unit - FLA of the largest compressor + LRA of the largest compressor)
- (4) Maximum effective RMS value of the current when the last compressor starts (FLA of the entire unit - FLA of the largest compressor + 0.6 x LRA of the largest compressor)
- (5) These values are determined for cables with operating temperature of 40°C, EPR insulation and a line with a maximum length of 50m. The line section must be determined by a qualified technician based on the protection devices, the length of the line, the type of cable used and the type of installation.
- (6) The correct line protection part must be determined by a qualified technician based on the length of the line, the type of cable used and the type of installation.

ZETA SKY HP R5 [R454B]

			14.4	16.4	18.4	20.4	24.4
General electrical specifications							
Max. absorbed current (FLA)	(1)	A	144,4	171,2	183,6	209,8	231,8
Nominal current (Inom)	(2)	A	87	105	111	126	137
cosφ standard unit	(2)		0.78	0.78	0.79	0.81	0.82
Nominal current with power factor correction (Inom)	(2)	A	69	85	91	107	114
cosφ unit with power factor correction	(2)		0.98	0.96	0.96	0.96	0.98
Maximum inrush current (MIC)	(3)	A	267	335	348	374	430
Maximum inrush current with soft-starter (MIC)	(4)	A	204	249	262	288	326
Power supply		V/ph/Hz	400/3~/50				
Power supply for auxiliary circuits		mm²	230-24/1~/50				
Suggested line section	(5)	mm²	3x50 + 1G25 mm2 FG16OR16	3x50 + 1G25 mm2 FG16OR16	3x70 + 1G35 mm2 FG16OR16	3x70 + 1G35 mm2 FG16OR16	3x95 + 1G50 mm2 FG16OR16
Suggested line protection	(6)		NH00gG 160A	NH00gG 160A	NH1gG 200A	NH1gG 200A	NH1gG 250A
Electrical specifications for fans							
Rated power of standard fan	(1)	n° x kW	3 x 1,5	3 x 1,5	3 x 1,5	4 x 1,5	4 x 1,5
Rated current of standard fan	(1)	n° x A	3 x 3,4	3 x 3,4	3 x 3,4	4 x 3,4	4 x 3,4
Rated power of EC fan	(2)	n° x kW	3 x 1,3	3 x 1,3	3 x 1,3	4 x 1,3	4 x 1,3
Rated current of EC fan	(2)	n° x A	3 x 1,9	3 x 1,9	3 x 1,9	4 x 1,9	4 x 1,9
Rated power of oversize EC fan	(2)	n° x kW	3 x 2,9	3 x 2,9	3 x 2,9	4 x 2,9	4 x 2,9
Rated current of oversized EC fan	(2)	n° x A	3 x 4,4	3 x 4,4	3 x 4,4	4 x 4,4	4 x 4,4

- (1) Data regarding the unit without accessories working in maximum power absorption conditions
- (2) Datum related to the unit without accessories working in standard conditions (A35°C; W12-7°C)
- (3) Maximum effective RMS value of the current when the last compressor starts (FLA of the entire unit - FLA of the largest compressor + LRA of the largest compressor)
- (4) Maximum effective RMS value of the current when the last compressor starts (FLA of the entire unit - FLA of the largest compressor + 0.6 x LRA of the largest compressor)
- (5) These values are determined for cables with operating temperature of 40°C, EPR insulation and a line with a maximum length of 50m. The line section must be determined by a qualified technician based on the protection devices, the length of the line, the type of cable used and the type of installation.
- (6) The correct line protection part must be determined by a qualified technician based on the length of the line, the type of cable used and the type of installation.

ZETA SKY HP SLN R5 [R454B]

			3.2	4.2	5.2	6.2	7.2	8.2
General electrical specifications								
Max. absorbed current (FLA)	(1)	A	45,2	51,2	55,2	60,2	71,8	79,0
Nominal current (Inom)	(2)	A	28.6	33	34	37	45	51
cosφ standard unit	(2)		0.82	0.79	0.8	0.81	0.84	0.81
Nominal current with power factor correction (Inom)	(2)	A	25	27	28	31	39	42
cosφ unit with power factor correction	(2)		0.95	0.95	0.95	0.97	0.97	0.98
Maximum inrush current (MIC)	(3)	A	121	168	168	177	195	237
Maximum inrush current with soft-starter (MIC)	(4)	A	82	111	111	118	132	159
Power supply		V/ph/Hz	400/3~+N/50					
Power supply for auxiliary circuits		V/ph/Hz	230-24/1~/50					
Power supply for auxiliary circuits	(5)	V/ph/Hz	4G10 mm2 FG16OR16	4G10 mm2 FG16OR16	4G10 mm2 FG16OR16	4G16 mm2 FG16OR16	3x25 + 1G16 mm2 FG16OR16	3x25 +1G16 mm2 FG16OR16
Suggested line protection	(6)		NH00gG 50A	NH00gG 50A	NH00gG 50A	NH00gG 63A	NH00gG 80A	NH00gG 80A
Electrical specifications for fans								
Rated power of standard fan	(1)	n° x kW	2 x 0,6	2 x 0,6	2 x 0,6	2 x 0,6	3 x 0,6	3 x 0,6
Rated current of standard fan	(1)	n° x A	2 x 2,6	2 x 2,6	2 x 2,6	2 x 2,6	3 x 2,6	3 x 2,6
Rated power of EC fan	(2)	n° x kW	2 x 0,8	2 x 0,8	2 x 0,8	2 x 0,8	3 x 0,8	3 x 0,8
Rated current of EC fan	(2)	n° x A	2 x 1,4	2 x 1,4	2 x 1,4	2 x 1,4	3 x 1,4	3 x 1,4
Rated power of oversize EC fan	(2)	n° x kW	2 x 1,0	2 x 1,0	2 x 1,0	2 x 1,0	3 x 1,0	3 x 1,0
Rated current of oversized EC fan	(2)	n° x A	2 x 1,6	2 x 1,6	2 x 1,6	2 x 1,6	3 x 1,6	3 x 1,6

			9.2	10.2	12.2	13.2	15.2	17.2
General electrical specifications								
Max. absorbed current (FLA)	(1)	A	92,5	104,9	126,9	128,4	145,4	189,4
Nominal current (Inom)	(2)	A	57	63	74	78	99	110
cosφ standard unit	(2)		0.79	0.81	0.82	0.81	0.81	0.8
Nominal current with power factor correction (Inom)	(2)	A	47	53	62	65	85	94
cosφ unit with power factor correction	(2)		0.96	0.96	0.98	0.97	0.95	0.95
Maximum inrush current (MIC)	(3)	A	257	269	325	326	386	427
Maximum inrush current with soft-starter (MIC)	(4)	A	171	183	221	222	258	290
Power supply		V/ph/Hz	400/3~/50					
Power supply for auxiliary circuits		V/ph/Hz	230-24/1~/50					
Power supply for auxiliary circuits	(5)	V/ph/Hz	3x25 + 1G16 mm2 FG16OR16	3x25 + 1G16 mm2 FG16OR16	3x35 + 1G25 mm2 FG16OR16	3x35 + 1G25 mm2 FG16OR16	3x50 + 1G25 mm2 FG16OR16	3x70 + 1G35 mm2 FG16OR16
Suggested line protection	(6)		NH00gG 100A	NH00gG 100A	NH00gG 125A	NH00gG 125A	NH00gG 160A	NH1gG 200A
Electrical specifications for fans								
Rated power of standard fan	(1)	n° x kW	2 x 1,5	2 x 1,5	2 x 1,5	3 x 1,5	3 x 1,5	3 x 1,5
Rated current of standard fan	(1)	n° x A	2 x 3,4	2 x 3,4	2 x 3,4	3 x 3,4	3 x 3,4	3 x 3,4
Rated power of EC fan	(2)	n° x kW	2 x 1,3	2 x 1,3	2 x 1,3	3 x 1,3	3 x 1,3	3 x 1,3
Rated current of EC fan	(2)	n° x A	2 x 1,9	2 x 1,9	2 x 1,9	3 x 1,9	3 x 1,9	3 x 1,9
Rated power of oversize EC fan	(2)	n° x kW	2 x 2,9	2 x 2,9	2 x 2,9	3 x 2,9	3 x 2,9	3 x 2,9
Rated current of oversized EC fan	(2)	n° x A	2 x 4,4	2 x 4,4	2 x 4,4	3 x 4,4	3 x 4,4	3 x 4,4

(1) Data regarding the unit without accessories working in maximum power absorption conditions

(2) Datum related to the unit without accessories working in standard conditions (A35°C; W12-7°C)

(3) Maximum effective RMS value of the current when the last compressor starts (FLA of the entire unit - FLA of the largest compressor + LRA of the largest compressor)

(4) Maximum effective RMS value of the current when the last compressor starts (FLA of the entire unit - FLA of the largest compressor + 0.6 x LRA of the largest compressor)

(5) These values are determined for cables with operating temperature of 40°C, EPR insulation and a line with a maximum length of 50m. The line section must be determined by a qualified technician based on the protection devices, the length of the line, the type of cable used and the type of installation.

(6) The correct line protection part must be determined by a qualified technician based on the length of the line, the type of cable used and the type of installation.

ZETA SKY HP SLN R5 [R454B]

			14.4	16.4	18.4	20.4	24.4
General electrical specifications							
Max. absorbed current (FLA)	(1)	A	144,4	171,2	183,6	209,8	231,8
Nominal current (Inom)	(2)	A	87	105	111	126	137
cosφ standard unit	(2)		0.78	0.78	0.79	0.81	0.82
Nominal current with power factor correction (Inom)	(2)	A	69	85	91	107	114
cosφ unit with power factor correction	(2)		0.98	0.96	0.96	0.96	0.98
Maximum inrush current (MIC)	(3)	A	267	335	348	374	430
Maximum inrush current with soft-starter (MIC)	(4)	A	204	249	262	288	326
Power supply		V/ph/Hz	400/3~/50				
Power supply for auxiliary circuits		V/ph/Hz	230-24/1~/50				
Power supply for auxiliary circuits	(5)	V/ph/Hz	3x50 + 1G25 mm2 FG16OR16	3x50 + 1G25 mm2 FG16OR16	3x70 + 1G35 mm2 FG16OR16	3x70 + 1G35 mm2 FG16OR16	3x95 + 1G50 mm2 FG16OR16
Suggested line protection	(6)		NH00gG 160A	NH00gG 160A	NH1gG 200A	NH1gG 200A	NH1gG 250A
Electrical specifications for fans							
Rated power of standard fan	(1)	n° x kW	3 x 1,5	3 x 1,5	3 x 1,5	4 x 1,5	4 x 1,5
Rated current of standard fan	(1)	n° x A	3 x 3,4	3 x 3,4	3 x 3,4	4 x 3,4	4 x 3,4
Rated power of EC fan	(2)	n° x kW	3 x 1,3	3 x 1,3	3 x 1,3	4 x 1,3	4 x 1,3
Rated current of EC fan	(2)	n° x A	3 x 1,9	3 x 1,9	3 x 1,9	4 x 1,9	4 x 1,9
Rated power of oversize EC fan	(2)	n° x kW	3 x 2,9	3 x 2,9	3 x 2,9	4 x 2,9	4 x 2,9
Rated current of oversized EC fan	(2)	n° x A	3 x 4,4	3 x 4,4	3 x 4,4	4 x 4,4	4 x 4,4

- (1) Data regarding the unit without accessories working in maximum power absorption conditions
- (2) Datum related to the unit without accessories working in standard conditions (A35°C; W12-7°C)
- (3) Maximum effective RMS value of the current when the last compressor starts (FLA of the entire unit - FLA of the largest compressor + LRA of the largest compressor)
- (4) Maximum effective RMS value of the current when the last compressor starts (FLA of the entire unit - FLA of the largest compressor + 0.6 x LRA of the largest compressor)
- (5) These values are determined for cables with operating temperature of 40°C, EPR insulation and a line with a maximum length of 50m. The line section must be determined by a qualified technician based on the protection devices, the length of the line, the type of cable used and the type of installation.
- (6) The correct line protection part must be determined by a qualified technician based on the length of the line, the type of cable used and the type of installation.

ZETA SKY Hi R7 [R32]

			3.1	4.1	6.2	8.2	10.2	12.2
General electrical specifications								
Max. absorbed current (FLA)	(1)	A	30,2	37,2	54,5	63,9	69,8	87,4
Nominal current (Inom)	(2)	A	21.5	29	36.7	47.2	54.5	64.8
cosφ standard unit	(2)		0.97	0.97	0.92	0.88	0.86	0.87
Nominal current with power factor correction (Inom)	(2)	A	-	-	-	-	-	-
cosφ unit with power factor correction	(2)		-	-	-	-	-	-
Maximum inrush current (MIC)	(3)	A	5	5	169	207	214	328
Power supply		V/ph/Hz	400/3~+N/50					
Power supply for auxiliary circuits		mm²	230-24/1~/50					
Suggested line section	(5)	mm²	4G6 FG16OR16	4G10 FG16OR16	4G16 FG16OR16	3x25 +1G16 FG16OR16	3x25 +1G16 FG16OR16	3x35 +1G25 FG16OR16
Suggested line protection	(6)		CH14gG 40A	NH00gG 50A	NH00gG 63A	NH00gG 80A	NH00gG 80A	NH00gG 100A
Electrical specifications for fans								
Rated power of standard fan	(1)	n° x kW	2 x 0,6	2 x 0,6	3 x 0,6	3 x 0,6	2 x 1,5	2 x 1,5
Rated current of standard fan	(1)	n° x A	2 x 2,6	2 x 2,6	3 x 2,6	3 x 2,6	2 x 3,4	2 x 3,4
Rated power of EC fan	(2)	n° x kW	2 x 0,8	2 x 0,8	3 x 0,8	3 x 0,8	2 x 1,3	2 x 1,3
Rated current of EC fan	(2)	n° x A	2 x 1,4	2 x 1,4	3 x 1,4	3 x 1,4	2 x 1,9	2 x 1,9
Rated power of oversize EC fan	(2)	n° x kW	2 x 1,0	2 x 1,0	3 x 1,0	3 x 1,0	2 x 2,9	2 x 2,9
Rated current of oversized EC fan	(2)	n° x A	2 x 1,6	2 x 1,6	3 x 1,6	3 x 1,6	2 x 4,4	2 x 4,4

ZETA SKY Hi R7 SLN [R32]

			3.1	4.1	6.2	8.2	10.2	12.2
General electrical specifications								
Max. absorbed current (FLA)	(1)	A	30,2	37,2	54,5	63,9	69,8	87,4
Nominal current (Inom)	(2)	A	21.5	29	36.7	47.2	54.5	64.8
cosφ standard unit	(2)		0.97	0.97	0.92	0.88	0.86	0.87
Nominal current with power factor correction (Inom)	(2)	A	-	-	-	-	-	-
cosφ unit with power factor correction	(2)		-	-	-	-	-	-
Maximum inrush current (MIC)	(3)	A	5	5	169	207	214	328
Power supply		V/ph/Hz	400/3~+N/50					
Power supply for auxiliary circuits		mm²	230-24/1~/50					
Suggested line section	(5)	mm²	4G6 FG16OR16	4G10 FG16OR16	4G16 FG16OR16	3x25 +1G16 FG16OR16	3x25 +1G16 FG16OR16	3x35 +1G25 FG16OR16
Suggested line protection	(6)		CH14gG 40A	NH00gG 50A	NH00gG 63A	NH00gG 80A	NH00gG 80A	NH00gG 100A
Electrical specifications for fans								
Rated power of standard fan	(1)	n° x kW	2 x 0,6	2 x 0,6	3 x 0,6	3 x 0,6	2 x 1,5	2 x 1,5
Rated current of standard fan	(1)	n° x A	2 x 2,6	2 x 2,6	3 x 2,6	3 x 2,6	2 x 3,4	2 x 3,4
Rated power of EC fan	(2)	n° x kW	2 x 0,8	2 x 0,8	3 x 0,8	3 x 0,8	2 x 1,3	2 x 1,3
Rated current of EC fan	(2)	n° x A	2 x 1,4	2 x 1,4	3 x 1,4	3 x 1,4	2 x 1,9	2 x 1,9
Rated power of oversize EC fan	(2)	n° x kW	2 x 1,0	2 x 1,0	3 x 1,0	3 x 1,0	2 x 2,9	2 x 2,9
Rated current of oversized EC fan	(2)	n° x A	2 x 1,6	2 x 1,6	3 x 1,6	3 x 1,6	2 x 4,4	2 x 4,4

- (1) Data regarding the unit without accessories working in maximum power absorption conditions
- (2) Datum related to the unit without accessories working in standard conditions (A35°C; W12-7°C)
- (3) Maximum effective RMS value of the current when the last compressor starts (FLA of the entire unit - FLA of the largest compressor + LRA of the largest compressor)
- (4) Maximum effective RMS value of the current when the last compressor starts (FLA of the entire unit - FLA of the largest compressor + 0.6 x LRA of the largest compressor)
- (5) These values are determined for cables with operating temperature of 40°C, EPR insulation and a line with a maximum length of 50m. The line section must be determined by a qualified technician based on the protection devices, the length of the line, the type of cable used and the type of installation.
- (6) The correct line protection part must be determined by a qualified technician based on the length of the line, the type of cable used and the type of installation.

ZETA SKY Hi HP R7 [R32]

			3.1	4.1	6.2	8.2	10.2	12.2
General electrical specifications								
Max. absorbed current (FLA)	(1)	A	30,2	37,2	54,5	63,9	69,8	87,4
Nominal current (Inom)	(2)	A	21.5	29	36.7	47.2	54.5	64.8
cosφ standard unit	(2)		0.97	0.97	0.92	0.88	0.86	0.87
Nominal current with power factor correction (Inom)	(2)	A	-	-	-	-	-	-
cosφ unit with power factor correction	(2)		-	-	-	-	-	-
Maximum inrush current (MIC)	(3)	A	5	5	169	207	214	328
Power supply		V/ph/Hz	400/3~+N/50					
Power supply for auxiliary circuits		mm²	230-24/1~/50					
Suggested line section	(5)	mm²	4G6 FG16OR16	4G10 FG16OR16	4G16 FG16OR16	3x25 +1G16 FG16OR16	3x25 +1G16 FG16OR16	3x35 +1G25 FG16OR16
Suggested line protection	(6)		CH14gG 40A	NH00gG 50A	NH00gG 63A	NH00gG 80A	NH00gG 80A	NH00gG 100A
Electrical specifications for fans								
Rated power of standard fan	(1)	n° x kW	2 x 0,6	2 x 0,6	3 x 0,6	3 x 0,6	2 x 1,5	2 x 1,5
Rated current of standard fan	(1)	n° x A	2 x 2,6	2 x 2,6	3 x 2,6	3 x 2,6	2 x 3,4	2 x 3,4
Rated power of EC fan	(2)	n° x kW	2 x 0,8	2 x 0,8	3 x 0,8	3 x 0,8	2 x 1,3	2 x 1,3
Rated current of EC fan	(2)	n° x A	2 x 1,4	2 x 1,4	3 x 1,4	3 x 1,4	2 x 1,9	2 x 1,9
Rated power of oversize EC fan	(2)	n° x kW	2 x 1,0	2 x 1,0	3 x 1,0	3 x 1,0	2 x 2,9	2 x 2,9
Rated current of oversized EC fan	(2)	n° x A	2 x 1,6	2 x 1,6	3 x 1,6	3 x 1,6	2 x 4,4	2 x 4,4

ZETA SKY Hi HP SLN R7 [R32]

			3.1	4.1	6.2	8.2	10.2	12.2
General electrical specifications								
Max. absorbed current (FLA)	(1)	A	30,2	37,2	54,5	63,9	69,8	87,4
Nominal current (Inom)	(2)	A	21.5	29	36.7	47.2	54.5	64.8
cosφ standard unit	(2)		0.97	0.97	0.92	0.88	0.86	0.87
Nominal current with power factor correction (Inom)	(2)	A	-	-	-	-	-	-
cosφ unit with power factor correction	(2)		-	-	-	-	-	-
Maximum inrush current (MIC)	(3)	A	5	5	169	206	212	326
Power supply		V/ph/Hz	400/3~+N/50					
Power supply for auxiliary circuits		mm²	230-24/1~/50					
Suggested line section	(5)	mm²	4G6 FG16OR16	4G10 FG16OR16	4G16 FG16OR16	3x25 +1G16 FG16OR16	3x25 +1G16 FG16OR16	3x35 +1G25 FG16OR16
Suggested line protection	(6)		CH14gG 40A	NH00gG 50A	NH00gG 63A	NH00gG 80A	NH00gG 80A	NH00gG 100A
Electrical specifications for fans								
Rated power of standard fan	(1)	n° x kW	2 x 0,6	2 x 0,6	3 x 0,6	3 x 0,6	2 x 1,5	2 x 1,5
Rated current of standard fan	(1)	n° x A	2 x 2,6	2 x 2,6	3 x 2,6	3 x 2,6	2 x 3,4	2 x 3,4
Rated power of EC fan	(2)	n° x kW	2 x 0,8	2 x 0,8	3 x 0,8	3 x 0,8	2 x 1,3	2 x 1,3
Rated current of EC fan	(2)	n° x A	2 x 1,4	2 x 1,4	3 x 1,4	3 x 1,4	2 x 1,9	2 x 1,9
Rated power of oversize EC fan	(2)	n° x kW	2 x 1,0	2 x 1,0	3 x 1,0	3 x 1,0	2 x 2,9	2 x 2,9
Rated current of oversized EC fan	(2)	n° x A	2 x 1,6	2 x 1,6	3 x 1,6	3 x 1,6	2 x 4,4	2 x 4,4

- (1) Data regarding the unit without accessories working in maximum power absorption conditions
- (2) Datum related to the unit without accessories working in standard conditions (A35°C; W12-7°C)
- (3) Maximum effective RMS value of the current when the last compressor starts (FLA of the entire unit - FLA of the largest compressor + LRA of the largest compressor)
- (4) Maximum effective RMS value of the current when the last compressor starts (FLA of the entire unit - FLA of the largest compressor + 0.6 x LRA of the largest compressor)
- (5) These values are determined for cables with operating temperature of 40°C, EPR insulation and a line with a maximum length of 50m. The line section must be determined by a qualified technician based on the protection devices, the length of the line, the type of cable used and the type of installation.
- (6) The correct line protection part must be determined by a qualified technician based on the length of the line, the type of cable used and the type of installation.

HYDRAULIC MODULES

ZETA SKY R7 [R32]

			3.2	4.2	5.2	6.2	7.2	8.2	9.2	10.2	12.2	13.2	15.2	17.2	14.4	16.4	18.4	20.4	24.4
Volume of the expansion vessel		I	18	18	18	18	18	18	18	18	18	18	18	18	18	18	18	18	18
Volume of the buffer tank CH		I	165	165	165	200	200	200	390	390	390	700	700	700	700	700	700	700	700
Small pumps																			
Pump model 1Pr, 2Pr			P21	P2	P22	P22	P22	P4	P23	P23	P23	P24	P24	P9	P24	P26	P26	P26	P26
Available head 1Pr	(1)	kPa	91	101	118	106	101	132	114	113	109	102	93	128	111	123	117	108	99
Available head 2Pr	(1)	kPa	82	92	107	94	85	115	88	82	73	85	73	101	94	98	89	76	58
Standard pumps																			
Pump model 1S, 2S			P2	P3	P4	P4	P4	P5	P7	P7	P9	P9	P9	P10	P9	P25	P25	P25	P25
Available head 1P	(1)	kPa	125	149	151	142	140	181	155	154	177	170	162	174	179	161	156	149	143
Available head 2P	(1)	kPa	116	140	140	130	124	164	129	123	141	153	142	147	162	136	128	117	102
Pumps for glycol (40% g.e.)																			
Pump model 1PG, 2PG			P4	P4	P4	P5	P23	P7	P7	P9	P9	P9	P25	P27	P25	P27	P27	P27	P27
Available head 1PG	(1)	kPa	143	133	138	174	137	170	129	156	157	136	144	172	159	189	185	176	163
Available head 2PG	(1)	kPa	133	122	125	159	118	148	96	116	109	114	117	138	136	159	150	135	110

(1) External air temperature 35°C, user-side heat exchanger water inlet/outlet temperature 12/7°C. Values in accordance with EN 14511.

ZETA SKY SLN R7 [R32]

			3.2	4.2	5.2	6.2	7.2	8.2	9.2	10.2	12.2	13.2	15.2	17.2	14.4	16.4	18.4	20.4	24.4
Volume of the expansion vessel		I	18	18	18	18	18	18	18	18	18	18	18	18	18	18	18	18	18
Volume of the buffer tank CH		I	165	165	165	200	200	200	390	390	390	700	700	700	700	700	700	700	700
Small pumps																			
Pump model 1Pr, 2Pr			P21	P2	P22	P22	P22	P4	P23	P23	P23	P24	P24	P9	P24	P26	P26	P26	P26
Available head 1Pr	(1)	kPa	91	101	118	106	101	132	114	113	109	102	93	128	111	123	117	108	99
Available head 2Pr	(1)	kPa	82	92	107	94	85	115	88	82	73	85	73	101	94	98	89	76	58
Standard pumps																			
Pump model 1S, 2S			P2	P3	P4	P4	P4	P5	P7	P7	P9	P9	P9	P10	P9	P25	P25	P25	P25
Available head 1P	(1)	kPa	125	149	151	142	140	181	155	154	177	170	162	174	179	161	156	149	143
Available head 2P	(1)	kPa	116	140	140	130	124	164	129	123	141	153	142	147	162	136	128	117	102
Pumps for glycol (40% g.e.)																			
Pump model 1PG, 2PG			P4	P4	P4	P5	P23	P7	P7	P9	P9	P9	P25	P27	P25	P27	P27	P27	P27
Available head 1PG	(1)	kPa	143	133	138	174	137	170	129	156	157	136	144	172	159	189	185	176	163
Available head 2PG	(1)	kPa	133	122	125	159	118	148	96	116	109	114	117	138	136	159	150	135	110

(1) External air temperature 35°C, user-side heat exchanger water inlet/outlet temperature 12/7°C. Values in accordance with EN 14511.

ZETA SKY HP R7 [R32]

			3.2	4.2	5.2	6.2	7.2	8.2	9.2	10.2	12.2	13.2	15.2	17.2	14.4	16.4	18.4	20.4	24.4
Volume of the expansion vessel		I	18	18	18	18	18	18	18	18	18	18	18	18	18	18	18	18	18
Volume of the buffer tank HP		I	165	165	165	200	200	200	390	390	390	700	700	700	700	700	700	700	700
Small pumps																			
Pump model 1Pr, 2Pr			P21	P2	P22	P22	P22	P4	P23	P23	P23	P24	P24	P9	P24	P26	P26	P26	P26
Available head 1Pr	(1)	kPa	91	101	118	106	101	132	114	113	109	102	93	128	111	123	117	108	99
Available head 2Pr	(1)	kPa	82	92	107	94	85	115	88	82	73	85	73	101	94	98	89	76	58
Standard pumps																			
Pump model 1S, 2S			P2	P3	P4	P4	P4	P5	P7	P7	P9	P9	P9	P10	P9	P25	P25	P25	P25
Available head 1P	(1)	kPa	125	149	151	142	140	181	155	154	177	170	162	174	179	161	156	149	143
Available head 2P	(1)	kPa	116	140	140	130	124	164	129	123	141	153	142	147	162	136	128	117	102
Pumps for glycol (40% g.e.)																			
Pump model 1PG, 2PG			P4	P4	P4	P5	P23	P7	P7	P9	P9	P9	P25	P27	P25	P27	P27	P27	P27
Available head 1PG	(1)	kPa	143	133	138	174	137	170	129	156	157	136	144	172	159	189	185	176	163
Available head 2PG	(1)	kPa	133	122	125	159	118	148	96	116	109	114	117	138	136	159	150	135	110

(1) External air temperature 35°C, user-side heat exchanger water inlet/outlet temperature 12/7°C. Values in accordance with EN 14511.

ZETA SKY HP SLN R7 [R32]

			3.2	4.2	5.2	6.2	7.2	8.2	9.2	10.2	12.2	13.2	15.2	17.2	14.4	16.4	18.4	20.4	24.4
Volume of the expansion vessel		I	18	18	18	18	18	18	18	18	18	18	18	18	18	18	18	18	18
Volume of the buffer tank HP		I	165	165	165	200	200	200	390	390	390	700	700	700	700	700	700	700	700
Small pumps																			
Pump model 1Pr, 2Pr			P21	P2	P22	P22	P22	P4	P23	P23	P23	P24	P24	P9	P24	P26	P26	P26	P26
Available head 1Pr	(1)	kPa	96	109	121	111	105	136	119	118	115	106	97	135	115	126	122	114	106
Available head 2Pr	(1)	kPa	87	100	110	99	90	119	94	89	80	90	78	109	98	102	95	84	68
Standard pumps																			
Pump model 1S, 2S			P2	P3	P4	P4	P4	P5	P7	P7	P9	P9	P9	P10	P9	P25	P25	P25	P25
Available head 1P	(1)	kPa	131	158	154	146	143	186	158	159	181	173	166	181	182	163	160	154	149
Available head 2P	(1)	kPa	122	149	143	134	128	169	133	130	146	157	147	155	165	139	133	124	111
Pumps for glycol (40% g.e.)																			
Pump model 1PG, 2PG			P4	P4	P4	P5	P23	P7	P7	P9	P9	P9	P25	P27	P25	P27	P27	P27	P27
Available head 1PG	(1)	kPa	144	136	141	180	141	174	134	161	162	149	147	177	161	193	189	181	171
Available head 2PG	(1)	kPa	135	126	129	166	122	153	103	124	117	129	121	145	139	164	156	144	122

(1) External air temperature 35°C, user-side heat exchanger water inlet/outlet temperature 12/7°C. Values in accordance with EN 14511.

ZETA SKY HP R5 [R454B]

			3.2	4.2	5.2	6.2	7.2	8.2	9.2	10.2	12.2	13.2	15.2	17.2	14.4	16.4	18.4	20.4	24.4
Volume of the expansion vessel		I	18	18	18	18	18	18	18	18	18	18	18	18	18	18	18	18	18
Volume of the buffer tank HP		I	165	165	165	200	200	200	390	390	390	700	700	700	700	700	700	700	700
Small pumps																			
Pump model 1Pr, 2Pr			P21	P2	P22	P22	P22	P4	P23	P23	P23	P24	P24	P9	P24	P26	P26	P26	P26
Available head 1Pr	(1)	kPa	102	109	122	110	104	133	128	116	106	110	78	129	110	123	120	103	101
Available head 2Pr	(1)	kPa	94	100	112	98	89	115	105	86	69	94	54	102	92	98	93	69	62
Standard pumps																			
Pump model 1S, 2S			P2	P3	P4	P4	P4	P5	P7	P7	P9	P9	P9	P10	P9	P25	P25	P25	P25
Available head 1P	(1)	kPa	137	158	155	145	142	183	168	156	175	177	147	175	177	161	159	145	144
Available head 2P	(1)	kPa	129	149	145	133	127	165	145	126	138	161	123	148	159	136	132	111	105
Pumps for glycol (40% g.e.)																			
Pump model 1PG, 2PG			P4	P4	P4	P5	P23	P7	P7	P9	P9	P9	P25	P27	P25	P27	P27	P27	P27
Available head 1PG	(1)	kPa	102	109	122	110	104	133	128	116	106	110	78	129	110	123	120	103	101
Available head 2PG	(1)	kPa	94	100	112	98	89	115	105	86	69	94	54	102	92	98	93	69	62

(1) External air temperature 35°C, user-side heat exchanger water inlet/outlet temperature 12/7°C. Values in accordance with EN 14511.

ZETA SKY HP SLN R5 [R454B]

			3.2	4.2	5.2	6.2	7.2	8.2	9.2	10.2	12.2	13.2	15.2	17.2	14.4	16.4	18.4	20.4	24.4
Volume of the expansion vessel		I	18	18	18	18	18	18	18	18	18	18	18	18	18	18	18	18	18
Volume of the buffer tank HP		I	165	165	165	200	200	200	390	390	390	700	700	700	700	700	700	700	700
Small pumps																			
Pump model 1Pr, 2Pr			P21	P2	P22	P22	P22	P4	P23	P23	P23	P24	P24	P9	P24	P26	P26	P26	P26
Available head 1Pr	(1)	kPa	106	117	125	114	107	137	132	120	112	113	78	136	113	126	124	109	108
Available head 2Pr	(1)	kPa	98	108	115	103	92	121	110	91	76	98	54	111	95	103	98	78	72
Standard pumps																			
Pump model 1S, 2S			P2	P3	P4	P4	P4	P5	P7	P7	P9	P9	P9	P10	P9	P25	P25	P25	P25
Available head 1P	(1)	kPa	142	166	158	148	145	186	172	161	179	180	147	181	181	164	162	149	150
Available head 2P	(1)	kPa	134	157	148	137	130	170	150	132	143	165	123	156	163	141	136	118	114
Pumps for glycol (40% g.e.)																			
Pump model 1PG, 2PG			P4	P4	P4	P5	P23	P7	P7	P9	P9	P9	P25	P27	P25	P27	P27	P27	P27
Available head 1PG	(1)	kPa	106	117	125	114	107	137	132	120	112	113	78	136	113	126	124	109	108
Available head 2PG	(1)	kPa	98	108	115	103	92	121	110	91	76	98	54	111	95	103	98	78	72

(1) External air temperature 35°C, user-side heat exchanger water inlet/outlet temperature 12/7°C. Values in accordance with EN 14511.

ZETA SKY Hi R7 [R32]

			3.1	4.1	6.2	8.2	10.2	12.2
Volume of the expansion vessel		I	5	5	5	18	18	18
Volume of the buffer tank CH		I	100	100	100	200	390	390
Small pumps								
Pump model 1Pr, 2Pr			P21	P2	P22	P4	P23	P23
Available head 1Pr	(1)	kPa	118	135	104	128	122	102
Available head 2Pr	(1)	kPa	109	127	90	110	95	87
Standard pumps								
Pump model 1S, 2S			P2	P3	P4	P5	P7	P9
Available head 1P	(1)	kPa	157	184	140	178	162	170
Available head 2P	(1)	kPa	148	176	126	160	135	155
Pumps for glycol								
Pump model 1PG, 2PG			P2	P4	P5	P7	P9	P9
Available head 1PG	(1)	kPa	132	138	173	163	162	151
Available head 2PG	(1)	kPa	124	128	157	141	128	134

(1) External air temperature 35°C, user-side heat exchanger water inlet/outlet temperature 12/7°C. Values in accordance with EN 14511.

ZETA SKY Hi R7 SLN [R32]

			3.1	4.1	6.2	8.2	10.2	12.2
Volume of the expansion vessel		I	5	5	5	18	18	18
Volume of the buffer tank CH		I	100	100	100	200	390	390
Small pumps								
Pump model 1Pr, 2Pr			P21	P2	P22	P4	P23	P23
Available head 1Pr	(1)	kPa	118	135	104	128	122	102
Available head 2Pr	(1)	kPa	109	127	90	110	95	87
Standard pumps								
Pump model 1S, 2S			P2	P3	P4	P5	P7	P9
Available head 1P	(1)	kPa	161	191	141	180	164	174
Available head 2P	(1)	kPa	152	182	126	162	137	158
Pumps for glycol								
Pump model 1PG, 2PG			P2	P4	P5	P7	P9	P9
Available head 1PG	(1)	kPa	131	138	173	162	162	151
Available head 2PG	(1)	kPa	122	128	156	140	127	133

(1) External air temperature 35°C, user-side heat exchanger water inlet/outlet temperature 12/7°C. Values in accordance with EN 14511.

ZETA SKY Hi HP R7 [R32]

			3.1	4.1	6.2	8.2	10.2	12.2
Volume of the expansion vessel		I	5	5	5	18	18	18
Volume of the buffer tank HP		I	100	100	100	200	390	390
Small pumps								
Pump model 1Pr, 2Pr			P21	P2	P22	P4	P23	P23
Available head 1Pr	(1)	kPa	118	135	104	127	122	107
Available head 2Pr	(1)	kPa	109	127	90	110	95	91
Standard pumps								
Pump model 1S, 2S			P2	P3	P4	P5	P7	P9
Available head 1P	(1)	kPa	158	184	140	176	162	174
Available head 2P	(1)	kPa	149	176	126	159	135	158
Pumps for glycol								
Pump model 1PG, 2PG			P2	P4	P5	P7	P9	P9
Available head 1PG	(1)	kPa	132	138	173	163	162	151
Available head 2PG	(1)	kPa	124	128	157	141	128	134

(1) External air temperature 35°C, user-side heat exchanger water inlet/outlet temperature 12/7°C. Values in accordance with EN 14511.

ZETA SKY Hi HP SLN R7 [R32]

			3.1	4.1	6.2	8.2	10.2	12.2
Volume of the expansion vessel		I	5	5	5	18	18	18
Volume of the buffer tank HP		I	100	100	100	200	390	390
Small pumps								
Pump model 1Pr, 2Pr			P21	P2	P22	P4	P23	P23
Available head 1Pr	(1)	kPa	118	134	104	126	120	106
Available head 2Pr	(1)	kPa	109	126	89	108	93	91
Standard pumps								
Pump model 1S, 2S			P2	P3	P4	P5	P7	P9
Available head 1P	(1)	kPa	158	183	139	175	160	172
Available head 2P	(1)	kPa	149	175	124	157	133	157
Pumps for glycol								
Pump model 1PG, 2PG			P2	P4	P5	P7	P9	P9
Available head 1PG	(1)	kPa	131	138	173	162	162	151
Available head 2PG	(1)	kPa	122	128	156	140	127	133

(1) External air temperature 35°C, user-side heat exchanger water inlet/outlet temperature 12/7°C. Values in accordance with EN 14511.

PUMP DATA

Model	Rated power	Rated current	Min. flow rate	Max. flow rate
	kW	A	m ³ /h	m ³ /h
P1	1,1	2,7	3	9
P2	0,9	2,1	3,6	9,6
P3	0,9	2,4	3,6	9,6
P4	1,1	2,5	7	18
P5	1,5	3,2	7	18
P6	1,9	4,2	7	18
P7	1,9	4,5	12	31,2
P8	3	6,1	6	20
P9	2,2	4,5	12	42
P10	3	6,1	12	42
P11	4	8,7	12	42
P12	5,5	10,4	12	42
P13	5,5	10,4	24	72
P14	7,5	13,7	24	72
P15	1,5	3,2	7	18
P16	1,9	4,2	7	18
P17	3	5,9	12	31,2
P18	3	6,1	12	42
P19	4	8,7	12	42
P20	7,5	13,7	24	72
P21	0,6	1,6	3,6	9,6
P22	0,8	1,9	7	18
P23	1,5	3,4	12	28,8
P24	1,5	3,2	12	42
P25	3	6,1	24	72
P26	2,2	4,5	24	60
P27	4	8,7	24	72

USER-SIDE EXCHANGER FLOW RATE FIELDS

The units are sized and optimized for the following nominal conditions: external air 35°C, inlet/outlet of the user-side heat exchanger 12/7°C.

The units can work at design conditions different from nominal conditions, provided that:

- the design condition falls within the operating limits specified below
- the unit is equipped with all the accessories necessary for operation (e.g. brine kit, fan speed adjuster)
- the flow rate at design conditions (that is, of the specific application) must always come within the allowed flow rate ranges specified below. If the design conditions require a water flow rate that does not come within the allowed operating range, you must contact our sales department that will identify the most suitable solution for the specific application.

ZETA SKY R7 [R32] / ZETA SKY R7 SLN [R32]

	Qmin	Qmax
	m ³ /h	m ³ /h
3.2	4	11,7
4.2	4,4	13
5.2	4,8	14,1
6.2	5,4	15,9
7.2	6,6	19,5
8.2	7	20,9
9.2	8,8	26,1
10.2	9,7	29
12.2	10,7	32
13.2	12,3	36,7
15.2	13,9	41,5
17.2	16	47,8
14.4	12,6	37,5
16.4	15	44,8
18.4	16,4	48,9
20.4	17,6	52,6
24.4	20,5	61,4

ZETA SKY R7 HP [R32] / ZETA SKY HP R7 SLN [R32]

	Qmin	Qmax
	m ³ /h	m ³ /h
3.2	4	11,7
4.2	4,4	13
5.2	4,8	14,1
6.2	5,4	15,9
7.2	6,6	19,5
8.2	7	20,9
9.2	8,8	26,1
10.2	9,7	29
12.2	10,7	32
13.2	12,3	36,7
15.2	13,9	41,5
17.2	16	47,8
14.4	12,6	37,5
16.4	15	44,8
18.4	16,4	48,9
20.4	17,6	52,6
24.4	20,5	61,4

ZETA SKY R7 Hi HP [R32] / ZETA SKY Hi HP R7 SLN [R32]

	Qmin	Qmax
	m ³ /h	m ³ /h
3.1	2,9	9,2
4.1	3,8	10,4
6.2	5,6	13,9
8.2	7,2	20,6
10.2	9	25,8
12.2	10,7	30,9

ZETA SKY R5 HP [R32] / ZETA SKY HP R5 SLN [R32]

	Qmin	Qmax
	m ³ /h	m ³ /h
3.2	4	11,7
4.2	4,4	13
5.2	4,8	14,1
6.2	5,4	15,9
7.2	6,6	19,5
8.2	7	20,9
9.2	8,8	26,1
10.2	9,7	29
12.2	10,7	32
13.2	12,3	36,7
15.2	13,9	41,5
17.2	16	47,8
14.4	12,6	37,5
16.4	15	44,8
18.4	16,4	48,9
20.4	17,6	52,6
24.4	20,5	61,4

ZETA SKY R7 Hi [R32] / ZETA SKY Hi R7 SLN [R32]

	Qmin	Qmax
	m ³ /h	m ³ /h
3.1	2,9	9,2
4.1	3,8	10,4
6.2	5,6	13,9
8.2	7,0	20,6
10.2	8,9	25,8
12.2	10,9	30,9

OPERATING LIMITS

ZETA SKY R7 - ZETA SKY R7 SLN

COOLING

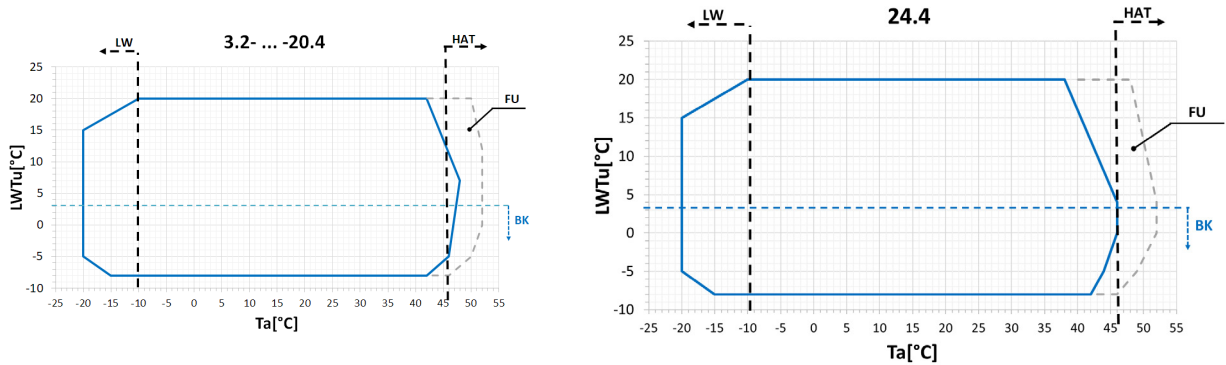

TOTAL RECOVERY

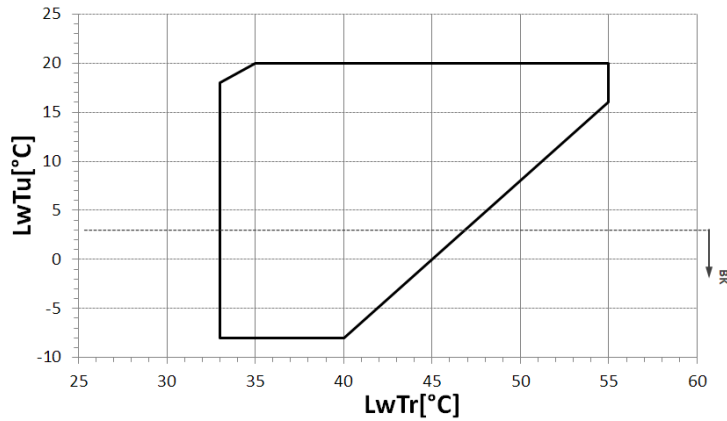

Ta: external air temperature

LWTu: water outlet temperature from the user-side heat exchanger

LWTr: water outlet temperature from the recovery exchanger

LW: in the indicated area, the unit can work only where there is no wind

FU: in the indicated area, the control could actuate a forced capacity reduction of the compressors so as to prevent tripping of the safety devices. For external air temperature above 52°C, a set-up including air conditioning of the electrical control panel is necessary: please contact our sales department.

BK: For LWTu lower or equal to +3°C, it is mandatory to fit the "Brine Kit" accessory

HAT: the "HAT" accessory is obligatory in the area indicated by the arrow.

For LWTu below +5°C, it is compulsory to use suitable percentages of antifreeze additives (glycols) to prevent ice formation in the exchanger.

The inlet and outlet temperatures of the user-side exchanger must be given on ordering to allow correct setting of the alarm parameters and verification of the sizing of the expansion valve.

The cooling set point can then be changed by the customer in an interval that, compared to the set point given on ordering, ranges from -1K up to the maximum temperature allowed by the above-stated operating limits.

The unit will be optimized to work at the set point temperatures given on ordering. For different set points, the cooling capacity provided and the level of efficiency of the machine could decrease and move away from these conditions.

ZETA SKY R7 - ZETA SKY R7 SLN

For models Zeta SKY R7 - Zeta SKY R7 SLN with Advanced control and Electronic expansion valve

COOLING

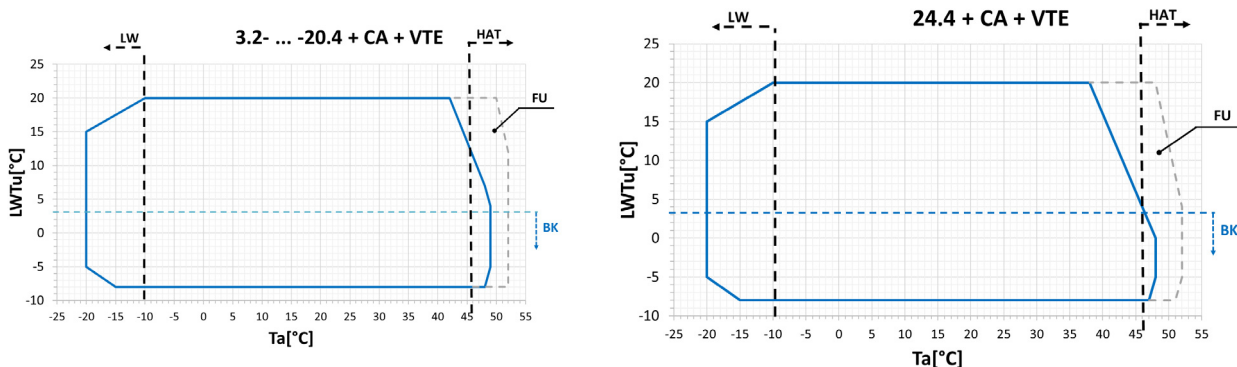

TOTAL RECOVERY

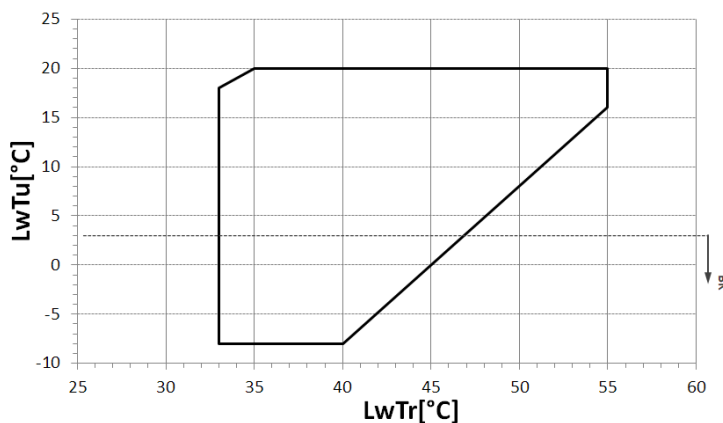

Ta: external air temperature

LWTu: water outlet temperature from the user-side heat exchanger

LWTr: water outlet temperature from the recovery exchanger

LW: in the indicated area, the unit can work only where there is no wind

FU: in the indicated area, the control could actuate a forced capacity reduction of the compressors so as to prevent tripping of the safety devices. For external air temperature above 52°C, a set-up including air conditioning of the electrical control panel is necessary: please contact our sales department.

BK: For $LWTu$ lower or equal to +3°C, it is mandatory to fit the "Brine Kit" accessory

HAT the "HAT" accessory is obligatory in the area indicated by the arrow.

For $LWTu$ below +5°C, it is compulsory to use suitable percentages of antifreeze additives (glycols) to prevent ice formation in the exchanger.

The inlet and outlet temperatures of the user-side exchanger must be given on ordering to allow correct setting of the alarm parameters and verification of the sizing of the expansion valve.

The cooling set point can then be changed by the customer in an interval that, compared to the set point given on ordering, ranges from -1K up to the maximum temperature allowed by the above-stated operating limits.

The unit will be optimized to work at the set point temperatures given on ordering. For different set points, the cooling capacity provided and the level of efficiency of the machine could decrease and move away from these conditions.

ZETA SKY HP R7 - ZETA SKY HP R7 SLN

COOLING

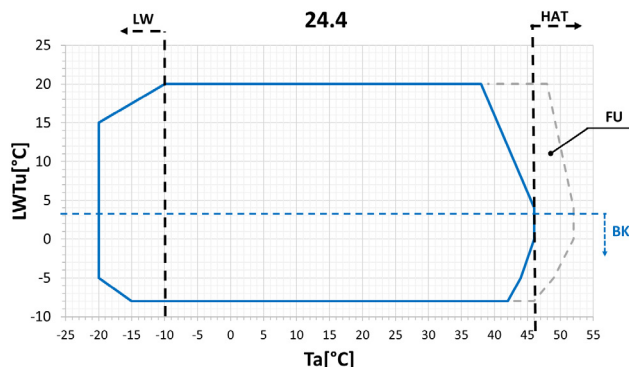
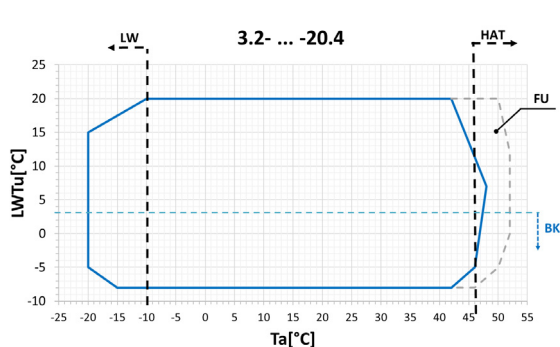

For models with HWT

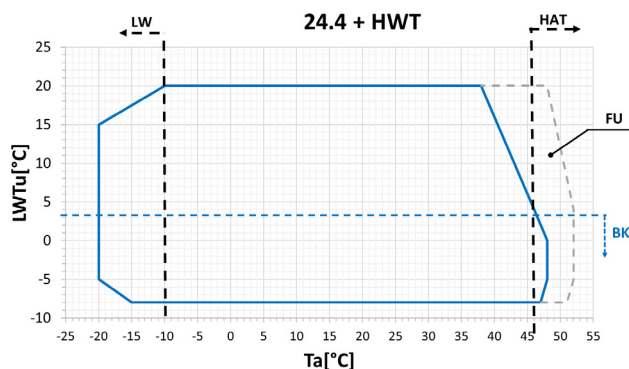
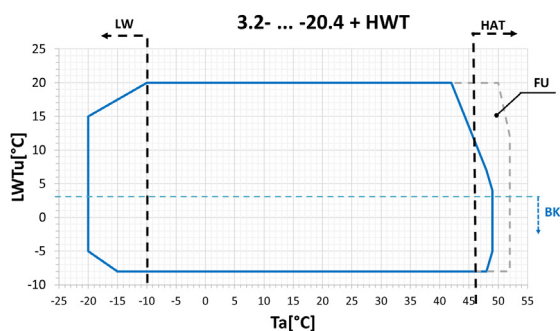

Ta: external air temperature

LWTu: water outlet temperature from the user-side heat exchanger

LWTr: water outlet temperature from the recovery exchanger

LW: in the indicated area, the unit can work only where there is no wind

FU: in the indicated area, the control could actuate a forced capacity reduction of the compressors so as to prevent tripping of the safety devices. For external air temperature above 52°C, a set-up including air conditioning of the electrical control panel is necessary: please contact our sales department.

BK: For LWTu lower or equal to +3°C, it is mandatory to fit the "Brine Kit" accessory

HAT the "HAT" accessory is obligatory in the area indicated by the arrow.

For LWTu below +5°C, it is compulsory to use suitable percentages of antifreeze additives (glycols) to prevent ice formation in the exchanger.

The inlet and outlet temperatures of the user-side exchanger must be given on ordering to allow correct setting of the alarm parameters and verification of the sizing of the expansion valve.

The cooling set point can then be changed by the customer in an interval that, compared to the set point given on ordering, ranges from -1K up to the maximum temperature allowed by the above-stated operating limits.

The unit will be optimized to work at the set point temperatures given on ordering. For different set points, the cooling capacity provided and the level of efficiency of the machine could decrease and move away from these conditions.

HEATING

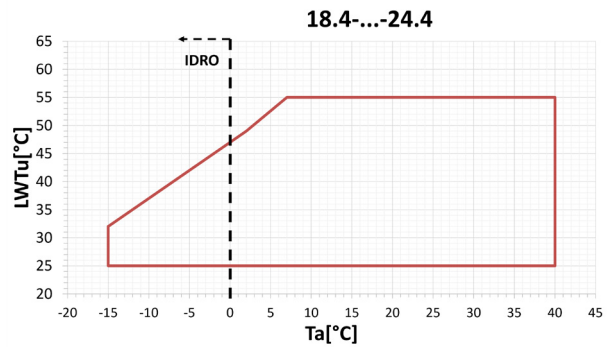
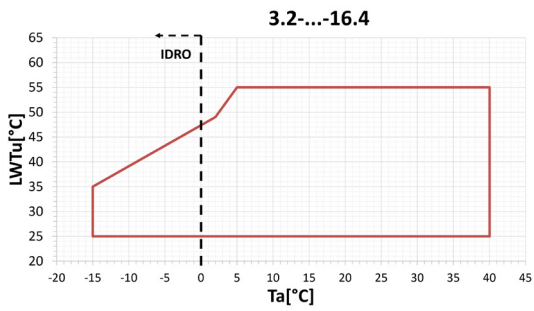

For models with HWT

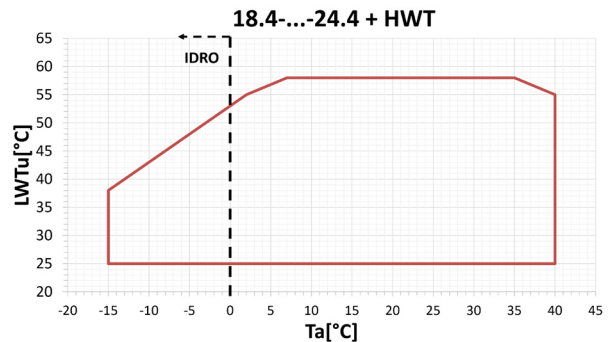
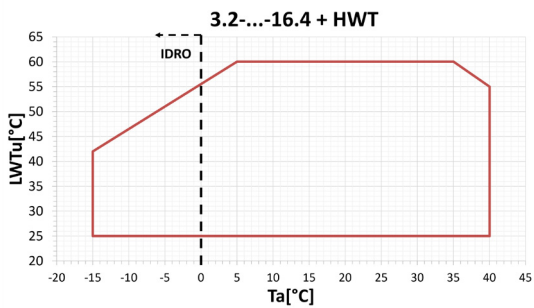

Ta: external air temperature

LWTu: water outlet temperature from the user-side heat exchanger

LWTr: water outlet temperature from the recovery exchanger

LW: in the indicated area, the unit can work only where there is no wind

FU: in the indicated area, the control could actuate a forced capacity reduction of the compressors so as to prevent tripping of the safety devices. For external air temperature above 52°C, a set-up including air conditioning of the electrical control panel is necessary: please contact our sales department.

BK: For LWTu lower or equal to +3°C, it is mandatory to fit the "Brine Kit" accessory

HAT the "HAT" accessory is obligatory in the area indicated by the arrow.

IDRO: In the event of extended use within the area indicated, we recommend using finned coil packs treated with the hydrophilic coating.

For LWTu below +5°C, it is compulsory to use suitable percentages of antifreeze additives (glycols) to prevent ice formation in the exchanger.

The inlet and outlet temperatures of the user-side exchanger must be given on ordering to allow correct setting of the alarm parameters and verification of the sizing of the expansion valve.

The cooling set point can then be changed by the customer in an interval that, compared to the set point given on ordering, ranges from -1K up to the maximum temperature allowed by the above-stated operating limits.

The unit will be optimized to work at the set point temperatures given on ordering. For different set points, the cooling capacity provided and the level of efficiency of the machine could decrease and move away from these conditions.

ZETA SKY HI R7 - ZETA SKY HI R7 SLN

COOLING

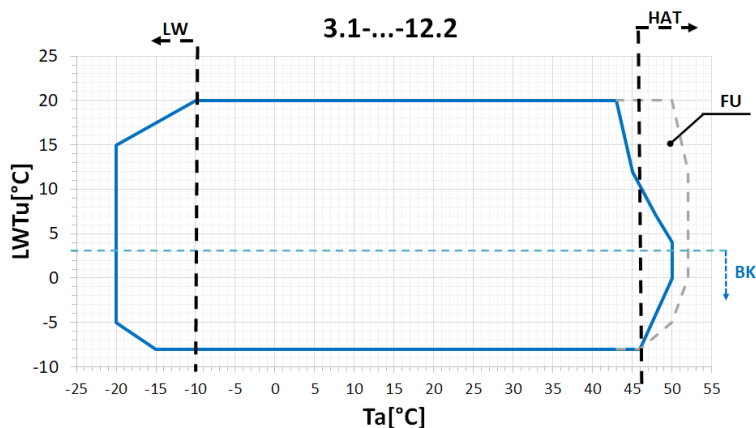

TOTAL RECOVERY

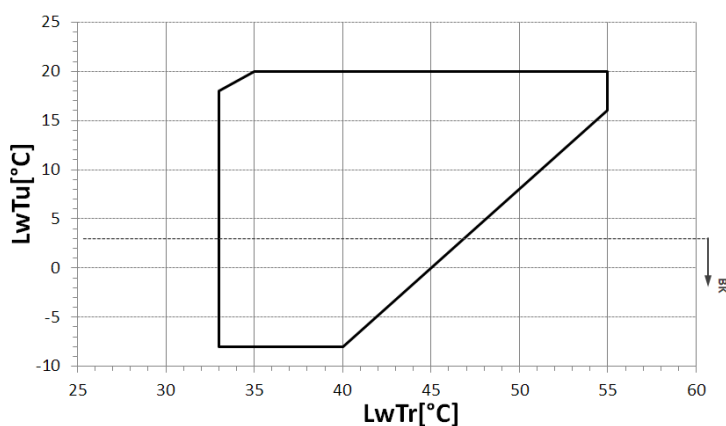

Ta: external air temperature

LWTu: water outlet temperature from the user-side heat exchanger

LWTr: water outlet temperature from the recovery exchanger

LW: in the indicated area, the unit can work only where there is no wind

FU: in the indicated area, the control could actuate a forced capacity reduction of the compressors so as to prevent tripping of the safety devices. For external air temperature above 52°C, a set-up including air conditioning of the electrical control panel is necessary: please contact our sales department.

BK: For LWTu lower or equal to +3°C, it is mandatory to fit the "Brine Kit" accessory

HAT the "HAT" accessory is obligatory in the area indicated by the arrow.

For LWTu below +5°C, it is compulsory to use suitable percentages of antifreeze additives (glycols) to prevent ice formation in the exchanger.

The inlet and outlet temperatures of the user-side exchanger must be given on ordering to allow correct setting of the alarm parameters and verification of the sizing of the expansion valve.

The cooling set point can then be changed by the customer in an interval that, compared to the set point given on ordering, ranges from -1K up to the maximum temperature allowed by the above-stated operating limits.

The unit will be optimized to work at the set point temperatures given on ordering. For different set points, the cooling capacity provided and the level of efficiency of the machine could decrease and move away from these conditions.

ZETA SKY HI HP R7 - ZETA SKY HI HP R7 SLN

COOLING

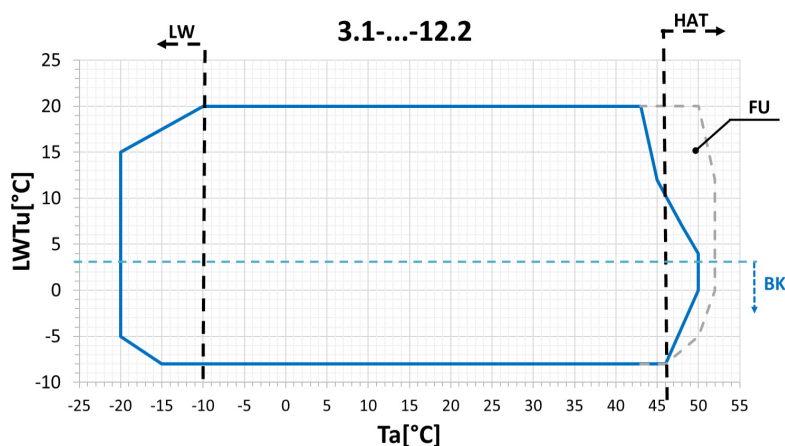

HEATING

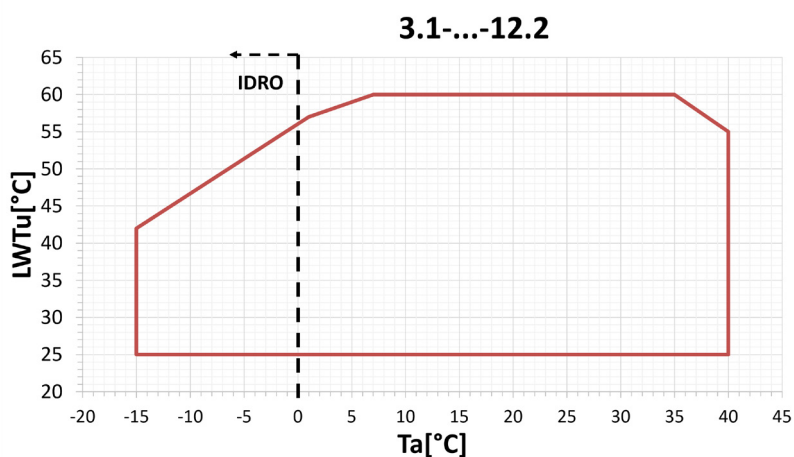

Ta: external air temperature

LWTu: water outlet temperature from the user-side heat exchanger

LWTr: water outlet temperature from the recovery exchanger

LW: in the indicated area, the unit can work only where there is no wind

FU: in the indicated area, the control could actuate a forced capacity reduction of the compressors so as to prevent tripping of the safety devices. For external air temperature above 52°C, a set-up including air conditioning of the electrical control panel is necessary: please contact our sales department.

BK: For LWTu lower or equal to +3°C, it is mandatory to fit the "Brine Kit" accessory

HAT the "HAT" accessory is obligatory in the area indicated by the arrow.

IDRO: In the event of extended use within the area indicated, we recommend using finned coil packs treated with the hydrophilic coating.

For LWTu below +5°C, it is compulsory to use suitable percentages of antifreeze additives (glycols) to prevent ice formation in the exchanger.

The inlet and outlet temperatures of the user-side exchanger must be given on ordering to allow correct setting of the alarm parameters and verification of the sizing of the expansion valve.

The cooling set point can then be changed by the customer in an interval that, compared to the set point given on ordering, ranges from -1K up to the maximum temperature allowed by the above-stated operating limits.

The unit will be optimized to work at the set point temperatures given on ordering. For different set points, the cooling capacity provided and the level of efficiency of the machine could decrease and move away from these conditions.

ZETA SKY HP R5 - ZETA SKY HP R5 SLN

COOLING

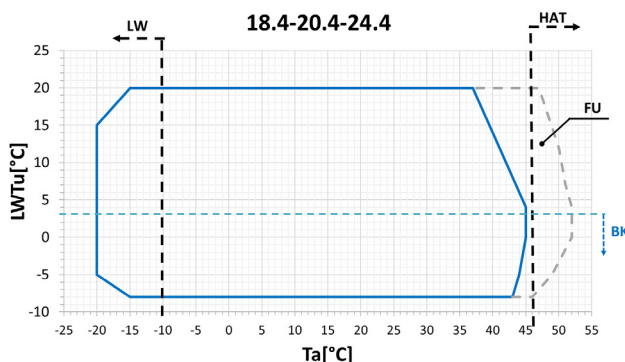
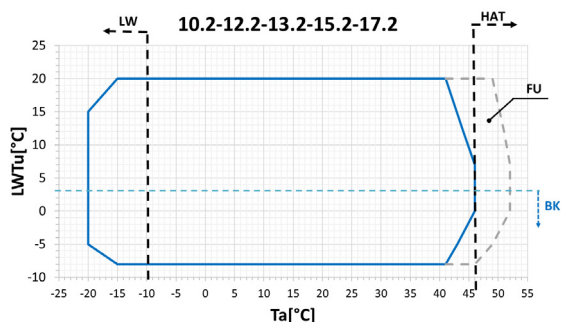
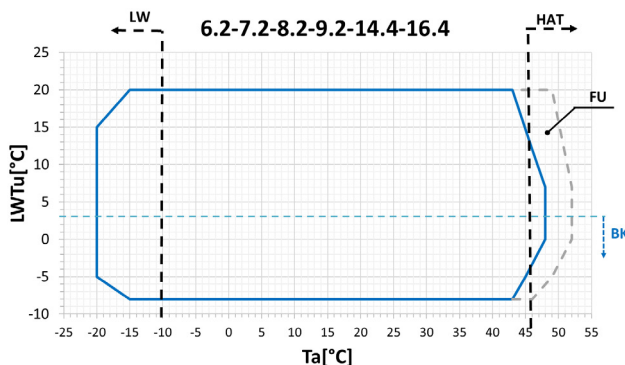
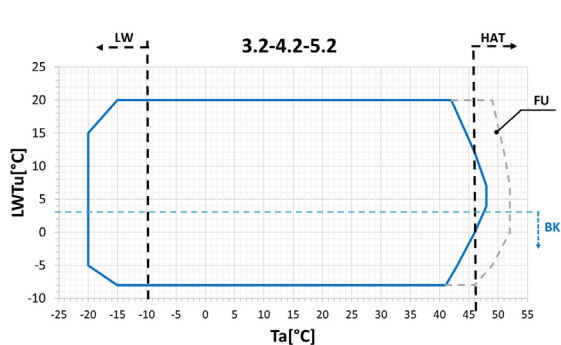

- Ta:** external air temperature
- LWTu:** water outlet temperature from the user-side heat exchanger
- LWTr:** water outlet temperature from the recovery exchanger
- LW:** in the indicated area, the unit can work only where there is no wind
- FU:** in the indicated area, the control could actuate a forced capacity reduction of the compressors so as to prevent tripping of the safety devices. For external air temperature above 52°C, a set-up including air conditioning of the electrical control panel is necessary: please contact our sales department.
- BK:** For LWTu lower or equal to +3°C, it is mandatory to fit the "Brine Kit" accessory
- HAT:** the "HAT" accessory is obligatory in the area indicated by the arrow.

For LWTu below +5°C, it is compulsory to use suitable percentages of antifreeze additives (glycols) to prevent ice formation in the exchanger.

The inlet and outlet temperatures of the user-side exchanger must be given on ordering to allow correct setting of the alarm parameters and verification of the sizing of the expansion valve.

The cooling set point can then be changed by the customer in an interval that, compared to the set point given on ordering, ranges from -1K up to the maximum temperature allowed by the above-stated operating limits.

The unit will be optimized to work at the set point temperatures given on ordering. For different set points, the cooling capacity provided and the level of efficiency of the machine could decrease and move away from these conditions.

HEATING

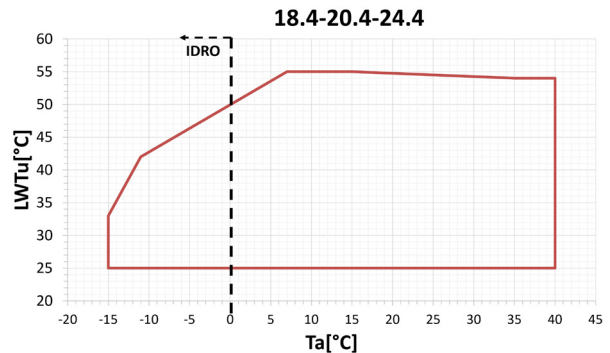
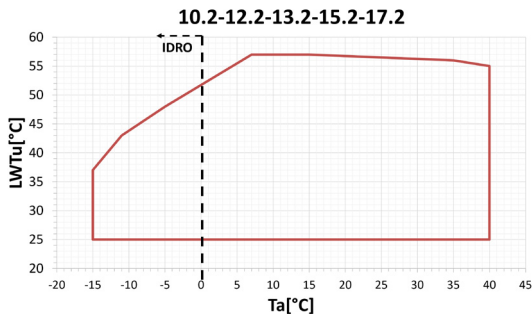
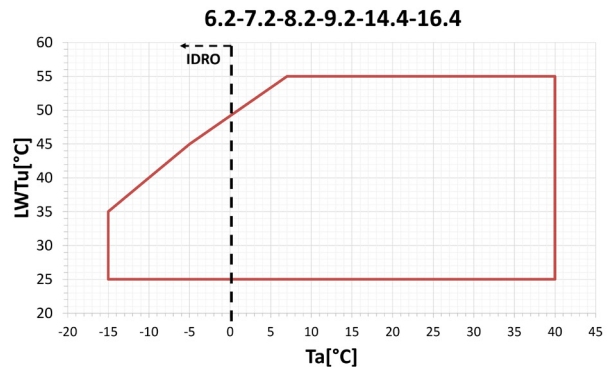
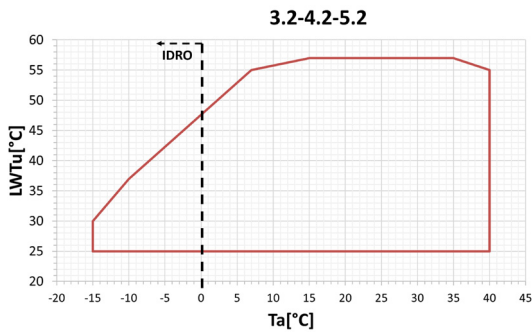

Ta: external air temperature

LWTu: water outlet temperature from the user-side heat exchanger

LWTr: water outlet temperature from the recovery exchanger

LW: in the indicated area, the unit can work only where there is no wind

FU: in the indicated area, the control could actuate a forced capacity reduction of the compressors so as to prevent tripping of the safety devices. For external air temperature above 52°C, a set-up including air conditioning of the electrical control panel is necessary: please contact our sales department.

BK: For LWTu lower or equal to +3°C, it is mandatory to fit the "Brine Kit" accessory

HAT the "HAT" accessory is obligatory in the area indicated by the arrow.

IDRO: In the event of extended use within the area indicated, we recommend using finned coil packs treated with the hydrophilic coating.

For LWTu below +5°C, it is compulsory to use suitable percentages of antifreeze additives (glycols) to prevent ice formation in the exchanger.

The inlet and outlet temperatures of the user-side exchanger must be given on ordering to allow correct setting of the alarm parameters and verification of the sizing of the expansion valve.

The cooling set point can then be changed by the customer in an interval that, compared to the set point given on ordering, ranges from -1K up to the maximum temperature allowed by the above-stated operating limits.

The unit will be optimized to work at the set point temperatures given on ordering. For different set points, the cooling capacity provided and the level of efficiency of the machine could decrease and move away from these conditions.

NOISE LEVELS

ZETA SKY R7 [R32]

Octave bands [dB]

	63 Hz		125 Hz		250 Hz		500 Hz		1000 Hz		2000 Hz		4000 Hz		8000 Hz		Total	
	Lw	Lp	Lw	Lp	Lw	Lp	Lw	Lp	Lw	Lp	Lw	Lp	Lw	Lp	Lw	Lp	[dB(A)]	
3.2	79	48	78	47	70	38	73	41	72	41	71	39	69	38	64	32	78	46
4.2	79	48	78	47	70	39	74	42	73	42	74	42	70	39	65	34	79	48
5.2	79	48	78	47	70	38	74	43	74	43	73	41	70	38	65	33	79	48
6.2	81	49	80	48	71	39	73	41	75	43	75	43	71	39	68	36	80	48
7.2	81	49	80	48	71	39	75	43	76	44	76	44	72	40	67	35	81	49
8.2	85	53	75	43	73	41	76	44	77	45	77	45	73	41	68	36	82	50
9.2	85	53	75	43	76	44	77	45	77	45	79	47	73	41	66	34	83	51
10.2	84	52	75	43	77	45	78	46	77	45	81	49	73	41	65	33	84	52
12.2	84	52	74	42	77	45	78	46	80	48	82	50	75	43	69	37	86	54
13.2	86	54	76	44	78	46	79	47	81	49	83	51	77	45	71	39	87	55
15.2	86	54	76	44	78	46	79	47	82	50	83	51	76	44	70	38	87	55
17.2	86	54	76	44	78	46	80	48	83	51	82	50	76	44	70	38	87	55
14.4	88	56	78	46	76	44	79	47	79	47	79	47	75	43	70	38	84	52
16.4	88	56	78	46	76	44	79	47	80	48	80	48	76	44	71	39	85	53
18.4	87	55	77	45	79	47	81	49	80	48	83	51	76	44	70	38	87	55
20.4	88	56	78	46	81	49	82	50	81	49	85	53	77	45	69	37	89	57
24.4	89	57	79	47	81	49	82	50	84	52	86	54	79	47	73	41	90	58

Reference conditions: outside air temperature 35°C; input/output water temperature into/from user-side heat exchanger 12/7°C; unit operating at rated capacity, without any option.

Lw: sound power levels. Values obtained from measures taken according to standard ISO 3744. Lw_tot is the only binding value.

Lp: sound pressure levels. Binding values starting from noise power levels referred to a distance of 10 m from the unit; source installed on a reflective surface and in ideal free field conditions with directivity factor Q=2. Non-binding values

The acoustic data are related to standard conditions in referable and reproducible operating conditions. All data with the exception of Lw_tot are provided for illustrative purposes only and can not be used for forecasting purposes or for the verification of binding limits. With special reference to noise emissions, the Manufacturer takes liability for their conformity, limited to the declared Lw_tot value. Any and all other Manufacturer's liability for the impact of such emissions in relation to the location of the machine and other conditions related to machine installation is excluded. The environment and the installation conditions, as well as the operating modes, can alter the sound emissions. Any assessment concerning these conditions falls within the area of competence of the plant designer and/or the fitter.

The certified standard performances and data can be verified in <https://www.eurovent-certification.com>

Some voluntary data are not certified (i.e. Noise Level for water source units; SCOP for units with Pdesign >70 KW; SCOP MT values).

ZETA SKY R7 LN [R32]

Octave bands [dB]

Total

	63 Hz		125 Hz		250 Hz		500 Hz		1000 Hz		2000 Hz		4000 Hz		8000 Hz		[dB(A)]	
	Lw	Lp	Lw	Lp	Lw	Lp	Lw	Lp	Lw	Lp	Lw	Lp	Lw	Lp	Lw	Lp	Lw	Lp
3.2	77	45	76	45	68	36	71	39	70	39	69	37	67	36	62	31	76	44
4.2	77	45	76	45	68	37	72	40	71	40	71	40	68	37	63	32	77	46
5.2	77	45	76	45	68	36	72	41	72	41	71	39	68	36	63	32	77	46
6.2	79	47	78	46	69	37	71	39	73	41	73	41	69	37	66	34	78	46
7.2	79	47	78	46	69	37	73	41	74	42	74	42	70	38	66	34	79	47
8.2	83	51	73	41	72	40	74	42	75	43	75	43	71	39	66	34	80	48
9.2	82	50	73	41	74	42	75	43	75	43	77	45	71	39	65	33	81	49
10.2	82	50	73	41	75	43	76	44	75	43	79	47	71	39	63	31	82	50
12.2	82	50	72	40	75	43	76	44	78	46	80	48	73	41	67	35	84	52
13.2	84	52	74	42	76	44	77	45	79	47	81	49	75	43	69	37	85	53
15.2	84	52	74	42	76	44	77	45	80	48	81	49	75	43	69	37	85	53
17.2	84	52	74	42	76	44	78	46	81	49	80	48	74	42	68	36	85	53
14.4	86	54	76	44	74	42	77	45	77	45	77	45	73	41	69	37	82	50
16.4	86	54	76	44	74	42	77	45	78	46	78	46	74	42	69	37	83	51
18.4	85	53	76	44	77	45	79	47	79	47	81	49	74	42	68	36	85	53
20.4	86	54	76	44	79	47	80	48	79	47	83	51	75	43	67	35	87	55
24.4	87	55	77	45	80	48	80	48	82	50	84	52	78	46	71	39	88	56

Reference conditions: outside air temperature 35°C; input/output water temperature into/from user-side heat exchanger 12/7°C; unit operating at rated capacity, without any option.

Lw: sound power levels. Values obtained from measures taken according to standard ISO 3744. Lw_tot is the only binding value.

Lp: sound pressure levels. Binding values starting from noise power levels referred to a distance of 10 m from the unit; source installed on a reflective surface and in ideal free field conditions with directivity factor Q=2. Non-binding values

The acoustic data are related to standard conditions in referable and reproducible operating conditions. All data with the exception of Lw_tot are provided for illustrative purposes only and can not be used for forecasting purposes or for the verification of binding limits. With special reference to noise emissions, the Manufacturer takes liability for their conformity, limited to the declared Lw_tot value. Any and all other Manufacturer's liability for the impact of such emissions in relation to the location of the machine and other conditions related to machine installation is excluded. The environment and the installation conditions, as well as the operating modes, can alter the sound emissions. Any assessment concerning these conditions falls within the area of competence of the plant designer and/or the fitter.

The certified standard performances and data can be verified in <https://www.eurovent-certification.com>

Some voluntary data are not certified (i.e. Noise Level for water source units; SCOP for units with Pdesign >70 KW; SCOP MT values).

ZETA SKY SLN R7 [R32]

Octave bands [dB]

	63 Hz		125 Hz		250 Hz		500 Hz		1000 Hz		2000 Hz		4000 Hz		8000 Hz		Total	
	Lw	Lp	Lw	Lp	Lw	Lp	Lw	Lp	Lw	Lp	Lw	Lp	Lw	Lp	Lw	Lp	[dB(A)]	
3.2	72	40	70	38	65	33	69	38	69	37	67	35	66	34	60	28	74	42
4.2	71	40	70	38	65	33	70	39	69	38	70	38	67	35	61	30	75	44
5.2	71	40	70	38	64	33	70	39	70	39	69	37	66	34	61	29	75	44
6.2	73	41	71	39	65	33	69	37	71	39	71	39	67	35	64	32	76	44
7.2	73	41	71	39	66	34	71	39	72	40	72	40	68	36	63	31	77	45
8.2	78	46	69	37	67	35	72	40	73	41	73	41	69	37	64	32	78	46
9.2	77	45	68	36	71	39	72	40	73	41	75	43	69	37	62	30	79	47
10.2	77	45	68	36	73	41	74	42	73	41	77	45	69	37	61	29	80	48
12.2	77	45	67	35	73	41	73	41	76	44	78	46	71	39	65	33	82	50
13.2	78	46	69	37	73	41	74	42	77	45	79	47	73	41	67	35	83	51
15.2	78	46	69	37	73	41	75	43	78	46	79	47	73	41	66	34	83	51
17.2	78	46	69	37	73	41	75	43	79	47	78	46	73	41	66	34	83	51
14.4	81	49	71	39	70	38	75	43	75	43	75	43	72	40	67	35	80	48
16.4	80	48	71	39	70	38	74	42	76	44	76	44	72	40	67	35	81	49
18.4	82	50	73	41	72	40	76	44	78	46	78	46	74	42	69	37	83	53
20.4	84	52	75	43	74	42	78	46	80	48	80	48	76	44	71	39	85	55
24.4	84	52	75	43	74	42	78	46	80	48	80	48	76	44	71	39	85	56

Reference conditions: outside air temperature 35°C; input/output water temperature into/from user-side heat exchanger 12/7°C; unit operating at rated capacity, without any option.

Lw: sound power levels. Values obtained from measures taken according to standard ISO 3744. Lw_tot is the only binding value.

Lp: sound pressure levels. Binding values starting from noise power levels referred to a distance of 10 m from the unit; source installed on a reflective surface and in ideal free field conditions with directivity factor Q=2. Non-binding values

The acoustic data are related to standard conditions in referable and reproducible operating conditions. All data with the exception of Lw_tot are provided for illustrative purposes only and can not be used for forecasting purposes or for the verification of binding limits. With special reference to noise emissions, the Manufacturer takes liability for their conformity, limited to the declared Lw_tot value. Any and all other Manufacturer's liability for the impact of such emissions in relation to the location of the machine and other conditions related to machine installation is excluded. The environment and the installation conditions, as well as the operating modes, can alter the sound emissions. Any assessment concerning these conditions falls within the area of competence of the plant designer and/or the fitter.

The certified standard performances and data can be verified in <https://www.eurovent-certification.com>

Some voluntary data are not certified (i.e. Noise Level for water source units; SCOP for units with Pdesign >70 KW; SCOP MT values).

ZETA SKY HP R7 [R32]

Octave bands [dB]

Total

	63 Hz		125 Hz		250 Hz		500 Hz		1000 Hz		2000 Hz		4000 Hz		8000 Hz		[dB(A)]	
	Lw	Lp	Lw	Lp	Lw	Lp	Lw	Lp	Lw	Lp	Lw	Lp	Lw	Lp	Lw	Lp	Lw	Lp
3.2	79	48	78	47	70	38	73	41	72	41	71	39	69	38	64	32	78	46
4.2	79	48	78	47	70	39	74	42	73	42	74	42	70	39	65	34	79	48
5.2	79	48	78	47	70	38	74	43	74	43	73	41	70	38	65	33	79	48
6.2	81	49	80	48	71	39	73	41	75	43	75	43	71	39	68	36	80	48
7.2	81	49	80	48	71	39	75	43	76	44	76	44	72	40	67	35	81	49
8.2	85	53	75	43	73	41	76	44	77	45	77	45	73	41	68	36	82	50
9.2	85	53	75	43	76	44	77	45	77	45	79	47	73	41	66	34	83	51
10.2	84	52	75	43	77	45	78	46	77	45	81	49	73	41	65	33	84	52
12.2	84	52	74	42	77	45	78	46	80	48	82	50	75	43	69	37	86	54
13.2	86	54	76	44	78	46	79	47	81	49	83	51	77	45	71	39	87	55
15.2	86	54	76	44	78	46	79	47	82	50	83	51	76	44	70	38	87	55
17.2	86	54	76	44	78	46	80	48	83	51	82	50	76	44	70	38	87	55
14.4	88	56	78	46	76	44	79	47	79	47	79	47	75	43	70	38	84	52
16.4	88	56	78	46	76	44	79	47	80	48	80	48	76	44	71	39	85	53
18.4	87	55	77	45	79	47	81	49	80	48	83	51	76	44	70	38	87	55
20.4	88	56	78	46	81	49	82	50	81	49	85	53	77	45	69	37	89	57
24.4	89	57	79	47	81	49	82	50	84	52	86	54	79	47	73	41	90	58

Reference conditions: outside air temperature 35°C; input/output water temperature into/from user-side heat exchanger 12/7°C; unit operating at rated capacity, without any option.

Lw: sound power levels. Values obtained from measures taken according to standard ISO 3744. Lw_tot is the only binding value.

Lp: sound pressure levels. Binding values starting from noise power levels referred to a distance of 10 m from the unit; source installed on a reflective surface and in ideal free field conditions with directivity factor Q=2. Non-binding values

The acoustic data are related to standard conditions in referable and reproducible operating conditions. All data with the exception of Lw_tot are provided for illustrative purposes only and can not be used for forecasting purposes or for the verification of binding limits. With special reference to noise emissions, the Manufacturer takes liability for their conformity, limited to the declared Lw_tot value. Any and all other Manufacturer's liability for the impact of such emissions in relation to the location of the machine and other conditions related to machine installation is excluded. The environment and the installation conditions, as well as the operating modes, can alter the sound emissions. Any assessment concerning these conditions falls within the area of competence of the plant designer and/or the fitter.

The certified standard performances and data can be verified in <https://www.eurovent-certification.com>

Some voluntary data are not certified (i.e. Noise Level for water source units; SCOP for units with Pdesign >70 KW; SCOP MT values).

ZETA SKY HP R7 LN [R32]

Octave bands [dB]

	63 Hz		125 Hz		250 Hz		500 Hz		1000 Hz		2000 Hz		4000 Hz		8000 Hz		Total	
	Lw	Lp	Lw	Lp	Lw	Lp	Lw	Lp	Lw	Lp	Lw	Lp	Lw	Lp	Lw	Lp	Lw	Lp
3.2	77	45	76	45	68	36	71	39	70	39	69	37	67	36	62	31	76	44
4.2	77	45	76	45	68	37	72	40	71	40	71	40	68	37	63	32	77	46
5.2	77	45	76	45	68	36	72	41	72	41	71	39	68	36	63	32	77	46
6.2	79	47	78	46	69	37	71	39	73	41	73	41	69	37	66	34	78	46
7.2	79	47	78	46	69	37	73	41	74	42	74	42	70	38	66	34	79	47
8.2	83	51	73	41	72	40	74	42	75	43	75	43	71	39	66	34	80	48
9.2	82	50	73	41	74	42	75	43	75	43	77	45	71	39	65	33	81	49
10.2	82	50	73	41	75	43	76	44	75	43	79	47	71	39	63	31	82	50
12.2	82	50	72	40	75	43	76	44	78	46	80	48	73	41	67	35	84	52
13.2	84	52	74	42	76	44	77	45	79	47	81	49	75	43	69	37	85	53
15.2	84	52	74	42	76	44	77	45	80	48	81	49	75	43	69	37	85	53
17.2	84	52	74	42	76	44	78	46	81	49	80	48	74	42	68	36	85	53
14.4	86	54	76	44	74	42	77	45	77	45	77	45	73	41	69	37	82	50
16.4	86	54	76	44	74	42	77	45	78	46	78	46	74	42	69	37	83	51
18.4	85	53	76	44	77	45	79	47	79	47	81	49	74	42	68	36	85	53
20.4	86	54	76	44	79	47	80	48	79	47	83	51	75	43	67	35	87	55
24.4	87	55	77	45	80	48	80	48	82	50	84	52	78	46	71	39	88	56

Reference conditions: outside air temperature 35°C; input/output water temperature into/from user-side heat exchanger 12/7°C; unit operating at rated capacity, without any option.

Lw: sound power levels. Values obtained from measures taken according to standard ISO 3744. Lw_tot is the only binding value.

Lp: sound pressure levels. Binding values starting from noise power levels referred to a distance of 10 m from the unit; source installed on a reflective surface and in ideal free field conditions with directivity factor Q=2. Non-binding values

The acoustic data are related to standard conditions in referable and reproducible operating conditions. All data with the exception of Lw_tot are provided for illustrative purposes only and can not be used for forecasting purposes or for the verification of binding limits. With special reference to noise emissions, the Manufacturer takes liability for their conformity, limited to the declared Lw_tot value. Any and all other Manufacturer's liability for the impact of such emissions in relation to the location of the machine and other conditions related to machine installation is excluded. The environment and the installation conditions, as well as the operating modes, can alter the sound emissions. Any assessment concerning these conditions falls within the area of competence of the plant designer and/or the fitter.

The certified standard performances and data can be verified in <https://www.eurovent-certification.com>

Some voluntary data are not certified (i.e. Noise Level for water source units; SCOP for units with Pdesign >70 KW; SCOP MT values).

ZETA SKY HP SLN R7 [R32]

Octave bands [dB]

	63 Hz		125 Hz		250 Hz		500 Hz		1000 Hz		2000 Hz		4000 Hz		8000 Hz		Total	
	Lw	Lp	Lw	Lp	Lw	Lp	Lw	Lp	Lw	Lp	Lw	Lp	Lw	Lp	Lw	Lp	[dB(A)]	
3.2	72	40	70	38	65	33	69	38	69	37	67	35	66	34	60	28	74	42
4.2	71	40	70	38	65	33	70	39	69	38	70	38	67	35	61	30	75	44
5.2	71	40	70	38	64	33	70	39	70	39	69	37	66	34	61	29	75	44
6.2	73	41	71	39	65	33	69	37	71	39	71	39	67	35	64	32	76	44
7.2	73	41	71	39	66	34	71	39	72	40	72	40	68	36	63	31	77	45
8.2	78	46	69	37	67	35	72	40	73	41	73	41	69	37	64	32	78	46
9.2	77	45	68	36	71	39	72	40	73	41	75	43	69	37	62	30	79	47
10.2	77	45	68	36	73	41	74	42	73	41	77	45	69	37	61	29	80	48
12.2	77	45	67	35	73	41	73	41	76	44	78	46	71	39	65	33	82	50
13.2	78	46	69	37	73	41	74	42	77	45	79	47	73	41	67	35	83	51
15.2	78	46	69	37	73	41	75	43	78	46	79	47	73	41	66	34	83	51
17.2	78	46	69	37	73	41	75	43	79	47	78	46	73	41	66	34	83	51
14.4	81	49	71	39	70	38	75	43	75	43	75	43	72	40	67	35	80	48
16.4	80	48	71	39	70	38	74	42	76	44	76	44	72	40	67	35	81	49
18.4	82	50	73	41	72	40	76	44	78	46	78	46	74	42	69	37	83	51
20.4	85	53	76	44	75	43	79	47	81	49	81	49	77	45	72	40	86	54
24.4	85	53	76	44	75	43	79	47	81	49	81	49	77	45	72	40	86	54

Reference conditions: outside air temperature 35°C; input/output water temperature into/from user-side heat exchanger 12/7°C; unit operating at rated capacity, without any option.

Lw: sound power levels. Values obtained from measures taken according to standard ISO 3744. Lw_tot is the only binding value.

Lp: sound pressure levels. Binding values starting from noise power levels referred to a distance of 10 m from the unit; source installed on a reflective surface and in ideal free field conditions with directivity factor Q=2. Non-binding values

The acoustic data are related to standard conditions in referable and reproducible operating conditions. All data with the exception of Lw_tot are provided for illustrative purposes only and can not be used for forecasting purposes or for the verification of binding limits. With special reference to noise emissions, the Manufacturer takes liability for their conformity, limited to the declared Lw_tot value. Any and all other Manufacturer's liability for the impact of such emissions in relation to the location of the machine and other conditions related to machine installation is excluded. The environment and the installation conditions, as well as the operating modes, can alter the sound emissions. Any assessment concerning these conditions falls within the area of competence of the plant designer and/or the fitter.

The certified standard performances and data can be verified in <https://www.eurovent-certification.com>

Some voluntary data are not certified (i.e. Noise Level for water source units; SCOP for units with Pdesign >70 KW; SCOP MT values).

ZETA SKY HP R5 [R454B]

Octave bands [dB]

	63 Hz		125 Hz		250 Hz		500 Hz		1000 Hz		2000 Hz		4000 Hz		8000 Hz		Total	
	Lw	Lp	Lw	Lp	Lw	Lp	Lw	Lp	Lw	Lp	Lw	Lp	Lw	Lp	Lw	Lp	Lw	Lp
3.2	79	48	78	47	70	38	73	41	72	41	71	39	69	38	64	32	78	46
4.2	79	48	78	47	70	39	74	42	73	42	74	42	70	39	65	34	79	48
5.2	79	48	78	47	70	38	74	43	74	43	73	41	70	38	65	33	79	48
6.2	81	49	80	48	71	39	73	41	75	43	75	43	71	39	68	36	80	48
7.2	81	49	80	48	71	39	75	43	76	44	76	44	72	40	67	35	81	49
8.2	85	53	75	43	73	41	76	44	77	45	77	45	73	41	68	36	82	50
9.2	85	53	75	43	76	44	77	45	77	45	79	47	73	41	66	34	83	51
10.2	84	52	75	43	77	45	78	46	77	45	81	49	73	41	65	33	84	52
12.2	84	52	74	42	77	45	78	46	80	48	82	50	75	43	69	37	86	54
13.2	86	54	76	44	78	46	79	47	81	49	83	51	77	45	71	39	87	55
15.2	86	54	76	44	78	46	79	47	82	50	83	51	76	44	70	38	87	55
17.2	86	54	76	44	78	46	80	48	83	51	82	50	76	44	70	38	87	55
14.4	88	56	78	46	76	44	79	47	79	47	79	47	75	43	70	38	84	52
16.4	88	56	78	46	76	44	79	47	80	48	80	48	76	44	71	39	85	53
18.4	87	55	77	45	79	47	81	49	80	48	83	51	76	44	70	38	87	55
20.4	88	56	78	46	81	49	82	50	81	49	85	53	77	45	69	37	89	57
24.4	89	57	79	47	81	49	82	50	84	52	86	54	79	47	73	41	90	58

Reference conditions: outside air temperature 35°C; input/output water temperature into/from user-side heat exchanger 12/7°C; unit operating at rated capacity, without any option.

Lw: sound power levels. Values obtained from measures taken according to standard ISO 3744. Lw_tot is the only binding value.

Lp: sound pressure levels. Binding values starting from noise power levels referred to a distance of 10 m from the unit; source installed on a reflective surface and in ideal free field conditions with directivity factor Q=2. Non-binding values

The acoustic data are related to standard conditions in referable and reproducible operating conditions. All data with the exception of Lw_tot are provided for illustrative purposes only and can not be used for forecasting purposes or for the verification of binding limits. With special reference to noise emissions, the Manufacturer takes liability for their conformity, limited to the declared Lw_tot value. Any and all other Manufacturer's liability for the impact of such emissions in relation to the location of the machine and other conditions related to machine installation is excluded. The environment and the installation conditions, as well as the operating modes, can alter the sound emissions. Any assessment concerning these conditions falls within the area of competence of the plant designer and/or the fitter.

The certified standard performances and data can be verified in <https://www.eurovent-certification.com>

Some voluntary data are not certified (i.e. Noise Level for water source units; SCOP for units with Pdesign >70 KW; SCOP MT values).

ZETA SKY HP R5 LN [R454B]

Octave bands [dB]

Total

	63 Hz		125 Hz		250 Hz		500 Hz		1000 Hz		2000 Hz		4000 Hz		8000 Hz		[dB(A)]	
	Lw	Lp	Lw	Lp	Lw	Lp	Lw	Lp	Lw	Lp	Lw	Lp	Lw	Lp	Lw	Lp	Lw	Lp
3.2	77	45	76	45	68	36	71	39	70	39	69	37	67	36	62	31	76	44
4.2	77	45	76	45	68	37	72	40	71	40	71	40	68	37	63	32	77	46
5.2	77	45	76	45	68	36	72	41	72	41	71	39	68	36	63	32	77	46
6.2	79	47	78	46	69	37	71	39	73	41	73	41	69	37	66	34	78	46
7.2	79	47	78	46	69	37	73	41	74	42	74	42	70	38	66	34	79	47
8.2	83	51	73	41	72	40	74	42	75	43	75	43	71	39	66	34	80	48
9.2	82	50	73	41	74	42	75	43	75	43	77	45	71	39	65	33	81	49
10.2	82	50	73	41	75	43	76	44	75	43	79	47	71	39	63	31	82	50
12.2	82	50	72	40	75	43	76	44	78	46	80	48	73	41	67	35	84	52
13.2	84	52	74	42	76	44	77	45	79	47	81	49	75	43	69	37	85	53
15.2	84	52	74	42	76	44	77	45	80	48	81	49	75	43	69	37	85	53
17.2	84	52	74	42	76	44	78	46	81	49	80	48	74	42	68	36	85	53
14.4	86	54	76	44	74	42	77	45	77	45	77	45	73	41	69	37	82	50
16.4	86	54	76	44	74	42	77	45	78	46	78	46	74	42	69	37	83	51
18.4	85	53	76	44	77	45	79	47	79	47	81	49	74	42	68	36	85	53
20.4	86	54	76	44	79	47	80	48	79	47	83	51	75	43	67	35	87	55
24.4	87	55	77	45	80	48	80	48	82	50	84	52	78	46	71	39	88	56

Reference conditions: outside air temperature 35°C; input/output water temperature into/from user-side heat exchanger 12/7°C; unit operating at rated capacity, without any option.

Lw: sound power levels. Values obtained from measures taken according to standard ISO 3744. Lw_tot is the only binding value.

Lp: sound pressure levels. Binding values starting from noise power levels referred to a distance of 10 m from the unit; source installed on a reflective surface and in ideal free field conditions with directivity factor Q=2. Non-binding values

The acoustic data are related to standard conditions in referable and reproducible operating conditions. All data with the exception of Lw_tot are provided for illustrative purposes only and can not be used for forecasting purposes or for the verification of binding limits. With special reference to noise emissions, the Manufacturer takes liability for their conformity, limited to the declared Lw_tot value. Any and all other Manufacturer's liability for the impact of such emissions in relation to the location of the machine and other conditions related to machine installation is excluded. The environment and the installation conditions, as well as the operating modes, can alter the sound emissions. Any assessment concerning these conditions falls within the area of competence of the plant designer and/or the fitter.

The certified standard performances and data can be verified in <https://www.eurovent-certification.com>

Some voluntary data are not certified (i.e. Noise Level for water source units; SCOP for units with Pdesign >70 KW; SCOP MT values).

ZETA SKY HP SLN R5 [R454B]

Octave bands [dB]

Total

	63 Hz		125 Hz		250 Hz		500 Hz		1000 Hz		2000 Hz		4000 Hz		8000 Hz		[dB(A)]	
	Lw	Lp	Lw	Lp	Lw	Lp	Lw	Lp	Lw	Lp	Lw	Lp	Lw	Lp	Lw	Lp	Lw	Lp
3.2	72	40	70	38	65	33	69	38	69	37	67	35	66	34	60	28	74	42
4.2	71	40	70	38	65	33	70	39	69	38	70	38	67	35	61	30	75	44
5.2	71	40	70	38	64	33	70	39	70	39	69	37	66	34	61	29	75	44
6.2	73	41	71	39	65	33	69	37	71	39	71	39	67	35	64	32	76	44
7.2	73	41	71	39	66	34	71	39	72	40	72	40	68	36	63	31	77	45
8.2	78	46	69	37	67	35	72	40	73	41	73	41	69	37	64	32	78	46
9.2	77	45	68	36	71	39	72	40	73	41	75	43	69	37	62	30	79	47
10.2	77	45	68	36	73	41	74	42	73	41	77	45	69	37	61	29	80	48
12.2	77	45	67	35	73	41	73	41	76	44	78	46	71	39	65	33	82	50
13.2	78	46	69	37	73	41	74	42	77	45	79	47	73	41	67	35	83	51
15.2	78	46	69	37	73	41	75	43	78	46	79	47	73	41	66	34	83	51
17.2	78	46	69	37	73	41	75	43	79	47	78	46	73	41	66	34	83	51
14.4	81	49	71	39	70	38	75	43	75	43	75	43	72	40	67	35	80	48
16.4	80	48	71	39	70	38	74	42	76	44	76	44	72	40	67	35	81	49
18.4	82	50	73	41	72	40	76	44	78	46	78	46	74	42	69	37	83	51
20.4	85	53	76	44	75	43	79	47	81	49	81	49	77	45	72	40	86	54
24.4	85	53	76	44	75	43	79	47	81	49	81	49	77	45	72	40	86	54

Reference conditions: outside air temperature 35°C; input/output water temperature into/from user-side heat exchanger 12/7°C; unit operating at rated capacity, without any option.

Lw: sound power levels. Values obtained from measures taken according to standard ISO 3744. Lw_tot is the only binding value.

Lp: sound pressure levels. Binding values starting from noise power levels referred to a distance of 10 m from the unit; source installed on a reflective surface and in ideal free field conditions with directivity factor Q=2. Non-binding values

The acoustic data are related to standard conditions in referable and reproducible operating conditions. All data with the exception of Lw_tot are provided for illustrative purposes only and can not be used for forecasting purposes or for the verification of binding limits. With special reference to noise emissions, the Manufacturer takes liability for their conformity, limited to the declared Lw_tot value. Any and all other Manufacturer's liability for the impact of such emissions in relation to the location of the machine and other conditions related to machine installation is excluded. The environment and the installation conditions, as well as the operating modes, can alter the sound emissions. Any assessment concerning these conditions falls within the area of competence of the plant designer and/or the fitter.

The certified standard performances and data can be verified in <https://www.eurovent-certification.com>

Some voluntary data are not certified (i.e. Noise Level for water source units; SCOP for units with Pdesign >70 KW; SCOP MT values).

ZETA SKY Hi R7 [R32]

Octave bands [dB]

	63 Hz		125 Hz		250 Hz		500 Hz		1000 Hz		2000 Hz		4000 Hz		8000 Hz		Total	
	Lw	Lp	Lw	Lp	Lw	Lp	Lw	Lp	Lw	Lp	Lw	Lp	Lw	Lp	Lw	Lp	[dB(A)]	
3.1	70	38	85	53	83	51	80	48	79	47	72	40	68	36	62	30	83	51
4.1	70	38	85	53	83	51	80	48	79	47	72	40	68	36	62	30	83	51
6.2	72	40	87	55	85	53	82	50	81	49	74	42	70	38	64	32	85	53
8.2	72	40	87	55	85	53	82	50	81	49	74	42	70	38	64	32	85	53
10.2	77	45	92	60	90	58	83	51	84	52	79	47	72	40	64	32	88	56
12.2	77	45	92	60	90	58	83	51	84	52	79	47	72	40	64	32	88	56

ZETA SKY Hi R7 SLN [R32]

Octave bands [dB]

	63 Hz		125 Hz		250 Hz		500 Hz		1000 Hz		2000 Hz		4000 Hz		8000 Hz		Total	
	Lw	Lp	Lw	Lp	Lw	Lp	Lw	Lp	Lw	Lp	Lw	Lp	Lw	Lp	Lw	Lp	[dB(A)]	
3.1	69	37	81	49	83	51	77	45	77	45	69	37	65	33	59	27	81	49
4.1	69	37	81	49	83	51	77	45	77	45	69	37	65	33	59	27	81	49
6.2	71	39	83	51	85	53	79	47	79	47	71	39	67	35	61	29	83	51
8.2	71	39	83	51	85	53	79	47	79	47	71	39	67	35	61	29	83	51
10.2	73	41	90	58	87	55	78	46	78	46	71	39	65	33	55	23	83	51
12.2	73	41	90	58	87	55	78	46	78	46	71	39	65	33	55	23	83	51

Reference conditions: outside air temperature 35°C; input/output water temperature into/from user-side heat exchanger 12/7°C; unit operating at rated capacity, without any option.

Lw: sound power levels. Values obtained from measures taken according to standard ISO 3744. Lw_tot is the only binding value.

Lp: sound pressure levels. Binding values starting from noise power levels referred to a distance of 10 m from the unit; source installed on a reflective surface and in ideal free field conditions with directivity factor Q=2. Non-binding values

The acoustic data are related to standard conditions in referable and reproducible operating conditions. All data with the exception of Lw_tot are provided for illustrative purposes only and can not be used for forecasting purposes or for the verification of binding limits. With special reference to noise emissions, the Manufacturer takes liability for their conformity, limited to the declared Lw_tot value. Any and all other Manufacturer's liability for the impact of such emissions in relation to the location of the machine and other conditions related to machine installation is excluded. The environment and the installation conditions, as well as the operating modes, can alter the sound emissions. Any assessment concerning these conditions falls within the area of competence of the plant designer and/or the fitter.

The certified standard performances and data can be verified in <https://www.eurovent-certification.com>

Some voluntary data are not certified (i.e. Noise Level for water source units; SCOP for units with Pdesign >70 KW; SCOP MT values).

ZETA SKY Hi HP R7 [R32]

Octave bands [dB]

																	Total	
	63 Hz		125 Hz		250 Hz		500 Hz		1000 Hz		2000 Hz		4000 Hz		8000 Hz		[dB(A)]	
	Lw	Lp	Lw	Lp	Lw	Lp	Lw	Lp	Lw	Lp	Lw	Lp	Lw	Lp	Lw	Lp	Lw	Lp
3.1	70	38	85	53	83	51	80	48	79	47	72	40	68	36	62	30	83	51
4.1	70	38	85	53	83	51	80	48	79	47	72	40	68	36	62	30	83	51
6.2	72	40	87	55	85	53	82	50	81	49	74	42	70	38	64	32	85	53
8.2	72	40	87	55	85	53	82	50	81	49	74	42	70	38	64	32	85	53
10.2	77	45	92	60	90	58	83	51	84	52	79	47	72	40	64	32	88	56
12.2	77	45	92	60	90	58	83	51	84	52	79	47	72	40	64	32	88	56

ZETA SKY Hi HP SLN R7 [R32]

Octave bands [dB]

																	Total	
	63 Hz		125 Hz		250 Hz		500 Hz		1000 Hz		2000 Hz		4000 Hz		8000 Hz		[dB(A)]	
	Lw	Lp	Lw	Lp	Lw	Lp	Lw	Lp	Lw	Lp	Lw	Lp	Lw	Lp	Lw	Lp	Lw	Lp
3.1	69	37	81	49	83	51	77	45	77	45	69	37	65	33	59	27	81	49
4.1	69	37	81	49	83	51	77	45	77	45	69	37	65	33	59	27	81	49
6.2	71	39	83	51	85	53	79	47	79	47	71	39	67	35	61	29	83	51
8.2	71	39	83	51	85	53	79	47	79	47	71	39	67	35	61	29	83	51
10.2	73	41	90	58	87	55	78	46	78	46	71	39	65	33	55	23	83	51
12.2	73	41	90	58	87	55	78	46	78	46	71	39	65	33	55	23	83	51

Reference conditions: outside air temperature 35°C; input/output water temperature into/from user-side heat exchanger 12/7°C; unit operating at rated capacity, without any option.

Lw: sound power levels. Values obtained from measures taken according to standard ISO 3744. Lw_tot is the only binding value.

Lp: sound pressure levels. Binding values starting from noise power levels referred to a distance of 10 m from the unit; source installed on a reflective surface and in ideal free field conditions with directivity factor Q=2. Non-binding values

The acoustic data are related to standard conditions in referable and reproducible operating conditions. All data with the exception of Lw_tot are provided for illustrative purposes only and can not be used for forecasting purposes or for the verification of binding limits. With special reference to noise emissions, the Manufacturer takes liability for their conformity, limited to the declared Lw_tot value. Any and all other Manufacturer's liability for the impact of such emissions in relation to the location of the machine and other conditions related to machine installation is excluded. The environment and the installation conditions, as well as the operating modes, can alter the sound emissions. Any assessment concerning these conditions falls within the area of competence of the plant designer and/or the fitter.

ZETA Sky Hi HP - Hi HP SLN

Model		3.1	4.1	6.2
Sound Power Level declared according to Regulation (EU) No. 813/2013	dB(A)	78	78	78

The certified standard performances and data can be verified in <https://www.eurovent-certification.com>

Some voluntary data are not certified (i.e. Noise Level for water source units; SCOP for units with Pdesign >70 KW; SCOP MT values).

CONFIGURATIONS THAT ARE NOT POSSIBLE

ZETA SKY R7 [R32] / ZETA SKY R7 SLN [R32]

	CHILLER ONLY							
	*Px	*PxS	DS	DS & *Px	DS & *PxS	DC	DC & *Px	DC & *PxS
3.2							(RFQ)	n.a.
4.2							(RFQ)	n.a.
5.2							(RFQ)	n.a.
6.2							(RFQ)	n.a.
7.2							(RFQ)	n.a.
8.2							(RFQ)	n.a.
9.2							(RFQ)	n.a.
10.2							(RFQ)	n.a.
12.2							(RFQ)	n.a.
13.2							(RFQ)	(RFQ)
15.2							(RFQ)	(RFQ)
17.2							(RFQ)	(RFQ)
14.4		(1)			(1)		(RFQ) (1)	n.a.
16.4		(1)			(1)		(RFQ) (1)	n.a.
18.4		(1)			(1)		(RFQ) (1)	n.a.
20.4		(1)			(1)		(RFQ) (1)	n.a.
24.4		(1)			(1)		(RFQ) (1)	n.a.

ZETA SKY HP R7 [R32] / ZETA SKY HP R7 SLN [R32]

	HEAT PUMP				
	HP & *Px	HP & *PxS	HP & DS	HP & DS & *Px	HP & DS & *PxS
3.2					
4.2					
5.2					
6.2					
7.2					
8.2					
9.2					
10.2					
12.2					
13.2					
15.2					
17.2					
14.4		(1)			(1)
16.4		(1)			(1)
18.4		(1)			(1)
20.4		(1)			(1)
24.4		(1)			(1)

n.a.: configuration not available

(1): The unit is realized on a structure bigger than standard

(RFQ): Please contact our sales department to verify its compatibility with the specific configuration and require a quotation

*: 1 o 2 pumps

Px: P / Pr / PM / PG (& S = tank, if explicitly indicated)

ZETA SKY HP R5 [R454B] / ZETA SKY HP R5 SLN [R454B]

	HEAT PUMP				
	HP & *Px	HP & *PxS	HP & DS	HP & DS & *Px	HP & DS & *PxS
3.2					
4.2					
5.2					
6.2					
7.2					
8.2					
9.2					
10.2					
12.2					
13.2					
15.2					
17.2					
14.4		(1)			(1)
16.4		(1)			(1)
18.4		(1)			(1)
20.4		(1)			(1)
24.4		(1)			(1)

ZETA SKY Hi R7 [R32] / ZETA SKY Hi R7 SLN [R32]

	CHILLER ONLY							
	*Px	*PxS	DS	DS & *Px	DS & *PxS	DC	DC & *Px	DC & *PxS
3.1					n.a.		n.a.	n.a.
4.1					n.a.		n.a.	n.a.
6.2								n.a.
8.2								n.a.
10.2								n.a.
12.2								n.a.

ZETA SKY Hi HP R7 [R32] - ZETA SKY Hi HP R7 SLN [R32]

	HEAT PUMP				
	HP & *Px	HP & *PxS	HP & DS	HP & DS & *Px	HP & DS & *PxS
3.1					n.a.
4.1					n.a.
6.2					
8.2					
10.2					
12.2					

n.a.: configuration not available

(1): The unit is realized on a structure bigger than standard

(RFQ): Please contact our sales department to verify its compatibility with the specific configuration and require a quotation

*: 1 o 2 pumps

Px: P / Pr / PM / PG (& S = tank, if explicitly indicated)

INSTALLATION ADVICE

The units described in this document are, by nature, strongly affected by the characteristics of the system, the working conditions and the installation site.

Remember that the unit must be installed by a qualified and skilled technician, and in compliance with the national legislation in force in the destination country.

The installation must be done in such a way that it will be possible to carry out all routine and non-routine maintenance operations.

Before starting any work, you must carefully read the "Installation, operation and maintenance manual" of the machine and do the necessary safety checks to prevent any malfunctioning or hazards.

We give some advice below that will allow you to increase the efficiency and reliability of the unit and therefore of the system into which it is inserted.

Water characteristics

To preserve the life of the exchangers, the water is required to comply with some quality parameters and it is therefore necessary to make sure its values fall within the ranges indicated in the following table:

Total hardness	2,0 ÷ 6,0 °f
Langelier index	- 0,4 ÷ 0,4
pH	7,5 ÷ 8,5
Electrical conductivity	10 ÷ 500 µS/cm
Organic elements	-
Hydrogen carbonate (HCO₃⁻)	70 ÷ 300 ppm
Sulphates (SO₄²⁻)	< 50 ppm
Hydrogen carbonate / Sulphates (HCO₃⁻/SO₄²⁻)	> 1
Chlorides (Cl⁻)	< 50 ppm
Nitrates (NO₃⁻)	< 50 ppm
Hydrogen sulphide (H₂S)	< 0,05 ppm
Ammonia (NH₃)	< 0,05 ppm
Sulphites (SO₃), free chlorine (Cl₂)	< 1 ppm
Carbon dioxide (CO₂)	< 5 ppm
Metal cations	< 0,2 ppm
Manganese ions (Mn⁺⁺)	< 0,2 ppm
Iron ions (Fe²⁺ , Fe³⁺)	< 0,2 ppm
Iron + Manganese	< 0,4 ppm
Phosphates (PO₄³⁻)	< 2 ppm
Oxygen	< 0,1 ppm

Installation of water filters on all the hydraulic circuits is obligatory.

The supply of the most suitable filters for the unit can be requested as accessory. In this case, the filters are supplied loose and must be installed by the customer following the instructions given in the installation, operation and maintenance manual.

Glycol mixtures

With temperatures below 5°C, it is mandatory to work with water and anti-freeze mixtures, and also change the safety devices (anti-freeze, etc.), which must be carried out by qualified authorised personnel or by the manufacturer.

Liquid outlet temperature or minimum ambient temperature	°C	0	-5	-10	-15	-20	-25	-30	-35	-40
Freezing point	°C	-5	-10	-15	-20	-25	-30	-35	-40	-45
Ethylene glycol	%	6	22	30	36	41	46	50	53	56
Propylene glycol	%	15	25	33	39	44	48	51	54	57

The quantity of antifreeze should be considered as % on weight

Minimum water content in the system

For correct operation of the unit, it is necessary to ensure a buffering on the system such as to comply with the minimum operating time considering the greater between the minimum OFF time and the minimum ON time. In short, these contribute to limiting the number of times the compressors are switched on per hour and to preventing undesired deviations from the set point of the delivered water temperature.

Larger amounts of water are in any case always preferable, because they allow a smaller number of starts and switch-offs of the compressors, less wear of them and an increase in the efficiency of the system as a consequence of a reduction in the number of transients.

It should also be pointed out that, for air-water units working in heat pump mode, the minimum amount of water must consider the need of the unit to carry out defrosting. Having an adequate buffering volume will allow prevention of too high drifts of the delivered water temperature at the end of the defrost cycle.

Please check "water Volume Design" Tool for a correct estimation of minimum water content of the system in "heat pump" working mode.

The following experimental formula allows to calculate the minimum water volume of the plant. Formula refers to unit operation in cooling mode and is also valid for heating mode if defrosting cycles are not taken in account.

$$V_{min} = \frac{P_{tot} \cdot 1000}{N} \cdot \frac{180}{\Delta T \rho C_p} + P_{tot} \cdot 0.25$$

where

V_{min} is the minimum water content of the system [l]

P_{tot} is the total cooling capacity of the machine [kW]

N: number of capacity reduction steps

ΔT : differential allowed on the water temperature. Unless otherwise specified, this value is considered to be 2.5K

ρ : density of the heat-carrying fluid. Unless otherwise specified, the density of water is considered

c_p : specific heat of the heat-carrying fluid. Unless otherwise specified, the specific heat of water is considered

Considering the use of water and grouping together some terms, the formula can be re-written as follows:

$$V_{min} = \frac{P_{tot}}{N} \cdot 17,2 + P_{tot} \cdot 0,25$$

N is equal to the number of compressors installed in the unit.

For units with inverter compressor:

- N=3 for units featuring one inverter-piloted compressor only;
- N=6 for units with 2 compressors of which one is controlled by inverter

In case of installation in cold climates where the unit has to perform defrosting cycles, it is suggested to use higher water content than that calculated with previous formula; due to very high volumes needed to completely compensate the negative effect of defrost on produced water temperature, are usually accepted higher temperature deviations than typical values accepted for cooling-only unit.

Water content necessary to balance defrost cycle effect on produced water temperatures, depends on various factors:

- type of system
- compressors and circuits number
- maximum temporary acceptable temperature difference from set-point
- Quantity of defrost cycles necessary to proper functioning of the unit (depending on external and working conditions)
- compressors and circuits number

Installation site

To determine the best installation site for the unit and its orientation, you should pay attention to the following points:

- compliance with the clearance spaces indicated in the official dimensional drawing of the unit must be guaranteed so as to ensure accessibility for routine and non-routine maintenance operations
- you should consider the origin of the hydraulic pipes and their diameters because these affect the radiuses of curvature and therefore the spaces needed for installing them
- you should consider the position of the cable inlet on the electrical control panel of the unit as regards the origin of the power supply
- if the installation includes several units side by side, you should consider the position and dimensions of the manifolds of the user-side exchangers and of any recovery exchangers
- if the installation includes several units side by side, you should consider that the minimum distance between units is 3 metres
- you should avoid all obstructions that can limit air circulation to the source-side exchanger or that can cause recirculation between air supply and intake
- you should consider the orientation of the unit to limit, as far as possible, exposure of the source-side exchanger to solar radiation
- if the installation area is particularly windy, the orientation and positioning of the unit must be such as to avoid air recirculation on the coils. If necessary, we advise making windbreak barriers in order to prevent malfunctioning.

Once the best position for the unit has been identified, you must check that the support slab has the following characteristics:

- its dimensions must be proportionate to those of the unit: if possible, longer and wider than the unit by at least 30 cm and 15/20cm higher than the surrounding surface
- it must be able to bear at least 4 times the operating weight of the unit
- it must allow level installation of the unit: although the unit is installed on a horizontal base, make slopes in the support surface to convey rain water or defrost water to drains, wells or in any case to places where it cannot generate an accident hazard due to ice formation. All heat pump version units are equipped with discharge manifolds for the condensed water; these can be manifolded to facilitate condensate discharge.

The units are designed and built to reduce to a minimum the level of vibration transmitted to the ground, but it is in any case advisable to use rubber or spring anti-vibration mounts, which are available as accessory and should be requested when ordering.

The anti-vibration mounts must be fixed on before positioning the unit on the ground.

In the event of installation on roofs or intermediate floors, the pipes must be isolated from the walls and ceilings.

It is advisable to avoid installation in cramped places, to prevent reverberations, reflections, resonances and acoustic interactions with elements outside the unit.

It is essential that any work done to soundproof the unit does not affect its correct installation or correct operation and, in particular, does not reduce the air flow rate to the source-side exchanger.

Installations that require the use of treated coils

If the unit has to be installed in an environment with a particularly aggressive atmosphere, coils with special treatments are available as options.

- e-coated microchannel coils (accessory not available for HP units)
- coils with anti-corrosion treatment (accessory available only for HP units or with Cu/Al coil)

A description of the individual accessories is available in the "Description of accessories" section.

The type of coil treatment should be chosen with regard to the environment in which the unit is to be installed, through observation of other structures and machinery with exposed metal surfaces present in the destination environment.

The cross observation criterion is the most valid method of selection currently available without having to carry out preliminary tests or measurements with instruments. The identified reference environments are:

- coastal/marine
- industrial
- urban with a high housing density
- rural

Please note that in cases where different conditions co-exist, even for short periods, the choice must be suitable for preserving the exchanger in the harsher environmental conditions and not in conditions between the worst and best situation.

Particular attention must be given in cases where an environment that is not particularly aggressive becomes aggressive as a consequence of a concomitant cause, for example, the presence of a flue outlet or an extraction fan.

We strongly suggest choosing one of the treatment options if at least one of the points listed below is verified:

- there are obvious signs of corrosion of the exposed metal surfaces in the installation area
- the prevailing winds come from the sea towards the unit
- the environment is industrial with a significant concentration of pollutants
- the environment is urban with a high population density
- the environment is rural with the presence of organic discharges and effluents

In particular, for installations near the coast, the following instructions apply:

- **for installations between 1 and 20 km from the coast of units with microchannel coil, we strongly recommend using the accessory "E-coated microchannel coils"**
- **for installations between 1 and 20 km from the coast of reversible units or units with Cu/Al coils, is strongly recommended using the accessory "Coil treated with anti-corrosion paints"**
- **for distances within a kilometre of the coast, we strongly recommend using the accessory "Coil treated with anti-corrosion paints" for all units**

To protect the exchangers from corrosion and ensure optimal operation of the unit, we advise following the recommendations given in the user, installation and maintenance manual for cleaning the coils.

Aeraulic head losses and options available for the ventilating section

With the exception of units for which oversize fans are required, as standard, the units are designed considering that, at the nominal air flow rate, the fans work with null available pressure.

If there are obstacles to free air flow, you should consider the additional aeraulic head losses that will cause a reduction of the air flow rate and a consequent deterioration of performance.

The following diagrams show the trend of cooling capacity (PC), EER, total absorbed power (Pabs) and reduction of the maximum external air temperature in chiller operating mode, depending on the aeraulic head losses that the fans will have to overcome.

AC fans (Ø 800)

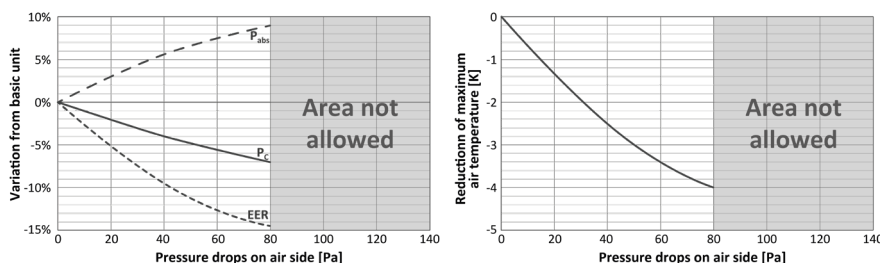

EC fans (Ø 800)

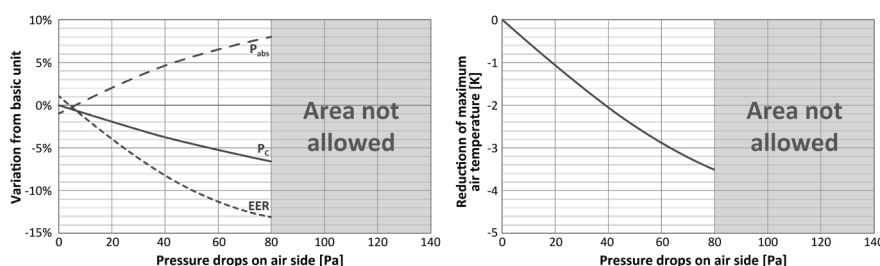

Oversize EC fans (Ø 800)

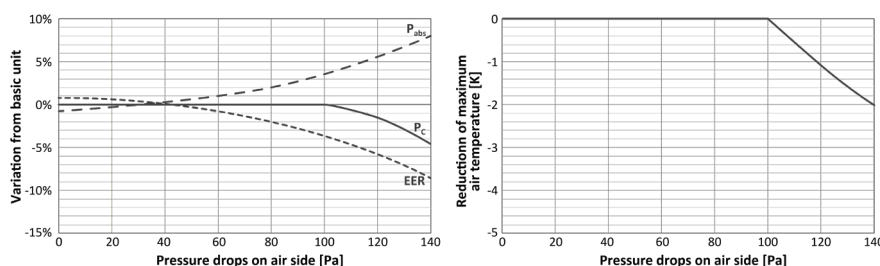

The indicated values are for the standard machine, without accessories, with AC fans and in any case in the absence of air recirculation.

Example: supposing you expect there to be obstacles that will generate an estimated aeraulic head loss of 60Pa. In this case, there are 3 possibilities:

- use the unit with standard AC fans: compared to ideal conditions, the output power will be reduced by about 5.5%, the total absorbed power will increase by about 7.5%, the EER will be reduced by about 12.5% and the maximum allowed external air temperature for operation at 100% will be reduced by about 3.4K compared to the nominal limit
- use the unit with EC fans: compared to the unit with AC fans working in ideal conditions, the output power will be reduced by about 5%, the total absorbed power will increase by about 6.5%, the EER will be reduced by about 11.5% and the maximum allowed external air temperature for operation at 100% will be reduced by about 2.8K compared to the nominal limit
- use the unit with oversize EC fans: compared to the unit with AC fans working in ideal conditions, the output power of the unit will be unchanged, the total absorbed power will increase by about 1%, the EER will be reduced by about 2% and the maximum external air temperature will remain the one shown in the diagram of the operating limits.

Swegon Operations s.r.l.

Via Valletta, 5 - 30010

Cantarana di Cona, (VE) Italy - T. +39 0426 921111 - F. +39 0426 302222

www.blueboxcooling.com - info@bluebox.it



Swegon Operations s.r.l. a socio unico - P.IVA 02481290282

Company directed and coordinated by Investment Latour (Sweden)